



550

General Merchandiser

Field Service Manual
and
Parts Catalog



Part Number 900-55000 C
Third Edition
First Printing
November 1994

Table 3-1

The following program settings are factory default settings and will be obtained upon operation of the DEFAULT MENU / INITIALIZE FULL routine.

Price Menu

PRICE SCHED - 1	ACTIVE
(Price Display all 99.95)	
PRICE SCHED - 2	ACTIVE
(Price Display .05 through .55)	
PRICE SCHED - 3	ACTIVE
(Price Display .60 through 1.10)	
SET PRICE 1 - \$.50	(5¢ to \$99.95)
SET PROD CODE - 0	(0 to 99)

MIS Menu

SET COIN TUBES -	NONE
BILL ACCTP EMPTY -	NO
CASH BOX EMPTY -	NO
PRINT MIS DATA -	NO
CLEAR MIS DATA -	NO
SALES (R) -	\$.00
SALES (N) -	\$.00 *
BAG TOTAL -	\$.00
CASHBOX -	\$.00
CARD SALES -	\$.00
BILL TOTALS -	\$.00
ONES -	\$.00
TWOS -	\$.00
FIVES -	\$.00
COIN TOTALS -	\$.00
\$1 COINS -	\$.00
QUARTERS -	\$.00
DIMES -	\$.00
NICKLES -	\$.00
RAND VEND -	\$.00
FREE VEND	\$.00
DISC 1 -	\$.00
DISC 2 -	\$.00
DISC 3 -	\$.00
TOTAL VENDS -	0
SCHED 1 VENDS -	0
SCHED 2 VENDS -	0
SCHED 3 VENDS -	0
VENDS PER SHELF -	0
RAND VENDS -	0
FREE VENDS -	0
DISC 1 VENDS -	0

DISC 2 VENDS -	0
DISC 3 VENDS -	0
MIS CLEAR COUNT -	X *
POWER LOSSES -	NO *
PRICE CHANGED -	NO *
OUT OF SERVICE -	NO *
TIME OVER HEALTH -	NO
MAX TEMPERATURE -	NO
MIN TEMPERATURE -	NO
CLOCK CHANGES -	0 *

Options Menu

MULTIVIEW -	OFF
FORCED VEND -	OFF
BILL ACCEPTOR -	OFF
FREE VEND -	OFF
RNDM FREE VEND -	OFF
DISPLAY TIME -	OFF
SET MACHINE ID -	NO
SECURITY CODE -	OFF
SET MESSAGE -	OFF
COLUMN DISPLAY -	SOLD
PROHIBIT VENDING -	NO
LANGUAGE -	ENGLISH

Clock Menu *

DATE -	1/17/92
SET DATE -	NO
TIME -	12:00
SET TIME -	NO

Conveyor Menu

CONVEYOR DELAY -	OFF
------------------	-----

Auto Price Menu

ENABLE SCHED 2 -	NO
ENABLE SCHED 3 -	NO

Discount Menu

SET DISCOUNT 1 -	NO
SET DISCOUNT 2 -	NO
SET DISCOUNT 3 -	NO

Diagnostic Menu

HEALTH TEST -	NO
CARD CREDIT -	\$.00
BAFFLE TEST	NONE
ZERO POS -	NO

Default Menu

MACHINE INIT -	NONE
PRINT BAUD RATE -	9600

* Denotes Non-resettable Values

Table 3-2 Miscellaneous Information

Maximum price:	\$99.95
Number of price schedules:	3
Number of discounts:	3
Maximum product code:	99
Free vend odds range:	50-3000
Maximum scrollable message length:	250 chars
Maximum fixed message length:	20 chars
Maximum machine ID length:	12 chars
Maximum security code length:	4 chars
Multiview time period:	3 minutes
Acceptable line voltage range:	105 VAC - 130 VAC (approx.)
Compressor turn on temperature:	41 degrees F
Compressor turn off temperature:	34 degrees F
Compressor minimum off time:	60 seconds
Maximum health control temperature:	45 degrees F
Maximum time over health control temperature:	60 seconds
Health Control pull down delay:	30 minutes
Health test delay time:	20 seconds

Hot Keys

The following buttons located on the horizontal display can be used to obtain diagnostic information from the vendor, while it is vend mode, without accessing the service mode or opening the service door. The button on the far left will be referred to as Button #1, and proceed sequentially from left to right.

- Button #1 + Button #1 - Date & Time
- Button #1 + Button #2 - Temperature °F
- Button #1 + Button #3 - Temperature °C
- Button #1 + Button #4 - Health Delay Time Remaining
- Button #1 + Button #5 - Machine I.D. Number
- Button #1 + Button #6 - N/A

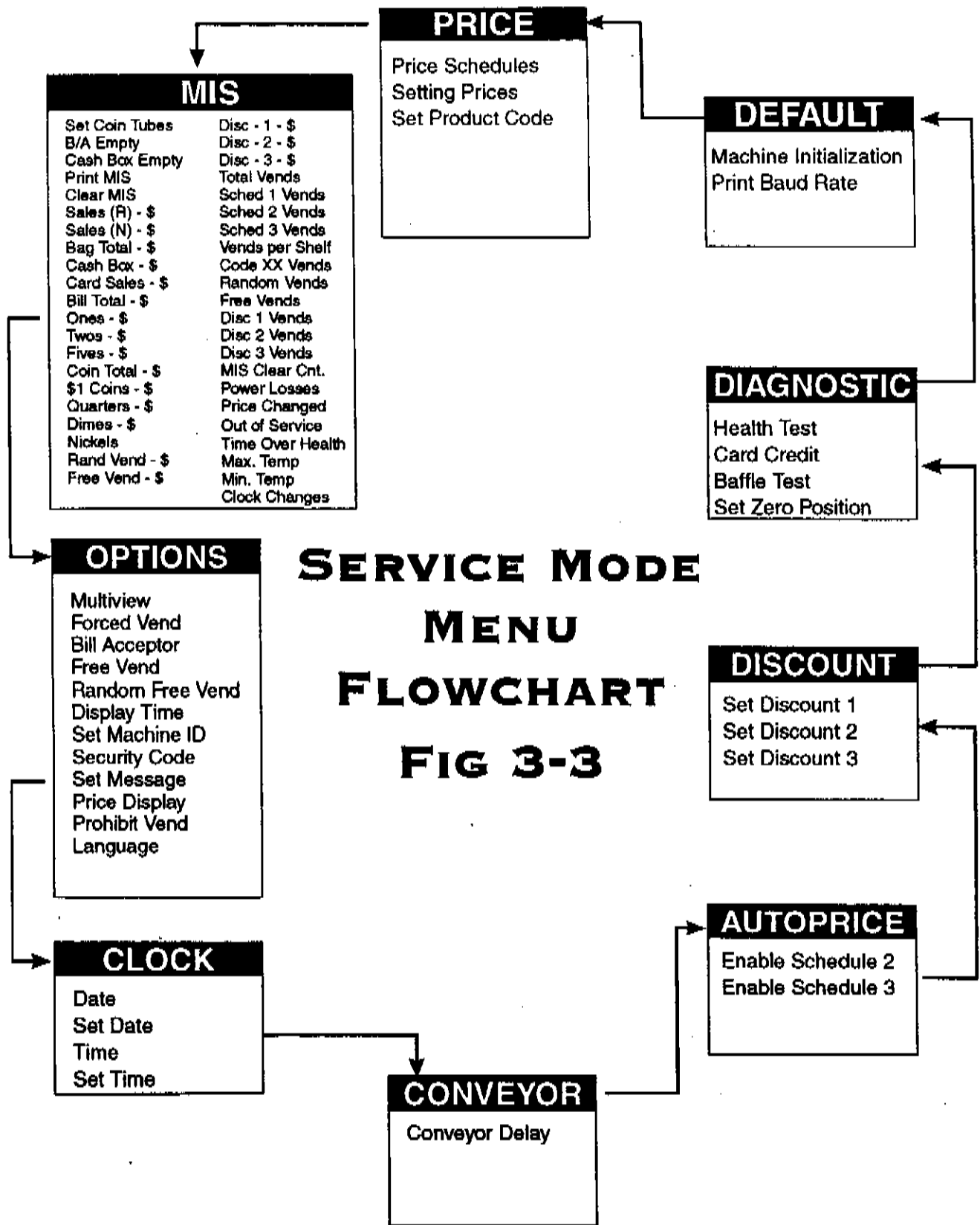

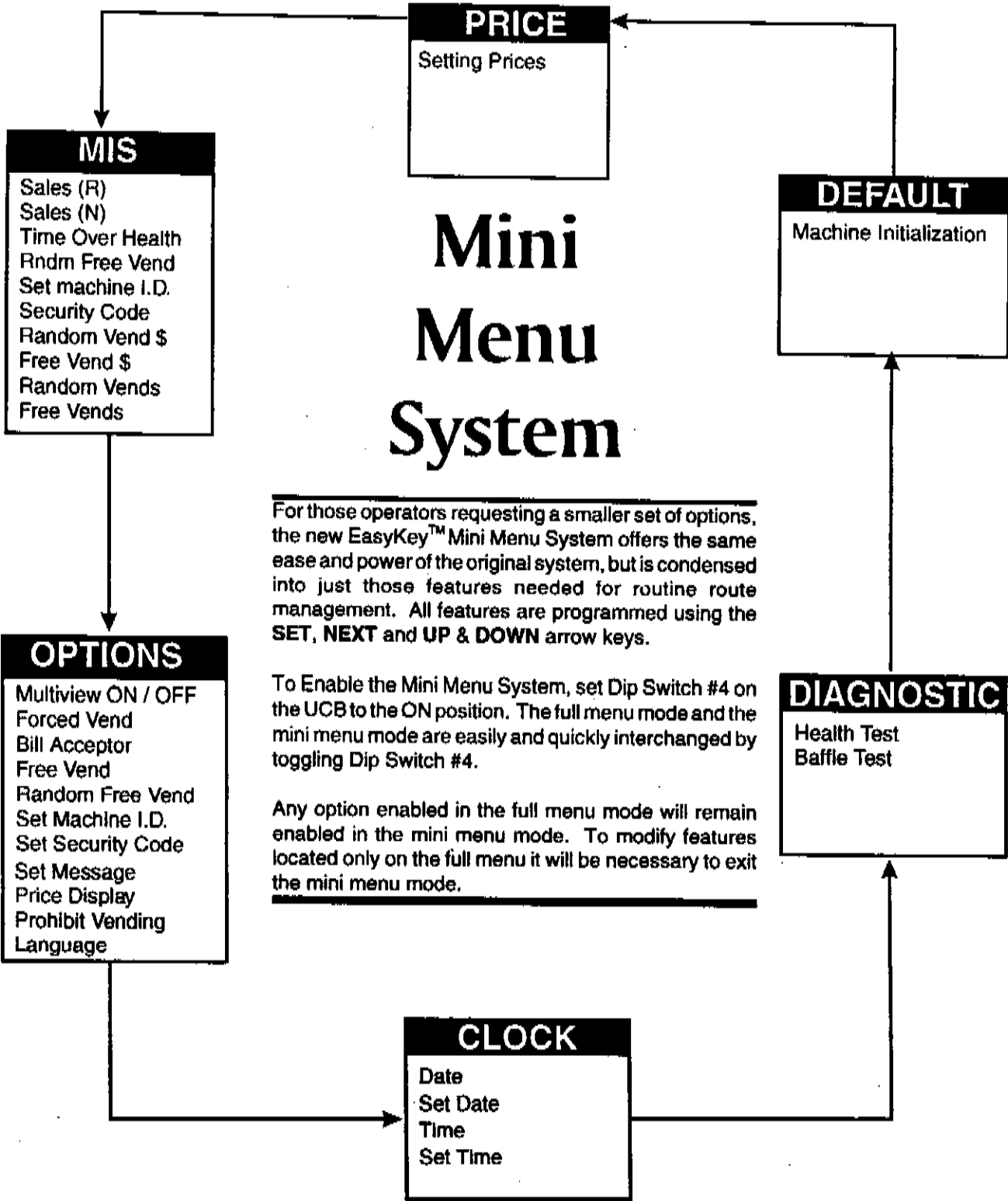

Figure 3-4

PRICE MENU

The PRICE menu contains the menu items that set the prices and product codes, and establish shelf configurations for the machine. In this menu the operator can specify the active price schedule.

A price schedule is a set of prices that is enabled for established periods of time. Price schedules are used to assign different prices to the same compartment at different times.

Product codes are numerical values assigned to products and are used to track the product's sales. Sales by product code are tabulated by the machine's MIS feature.

Shelf Configuration

The purpose of the SHELF CONFIGURATION option is to establish the number of compartments on each shelf.

To configure shelves:

- 1) With ---PRICE MENU--- on the display, press the **SET** key, "PRICE SCHED - 1 ACTIVE" will be displayed on the message center.
- 2) Press the **▲** or **▼** key until "SHELF CONFIGURATION" is displayed on the message center.
- 4) Press the first selection button on the left side of the horizontal display once. It will start blinking.

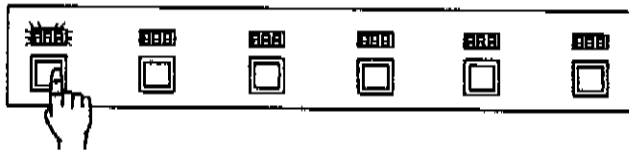

- 5) If the selection is to contain only the first compartment, press the selection button again.
- 6) If the selection is to contain more than one compartment, press the selection button that will be the far right boundary of the selection.

NOTE: When shelves are reconfigured, prices are reset to the maximum price.

- 7) The display to the immediate right of the selection just configured will begin to blink.

Repeat steps 5 & 6 until the entire shelf is configured.

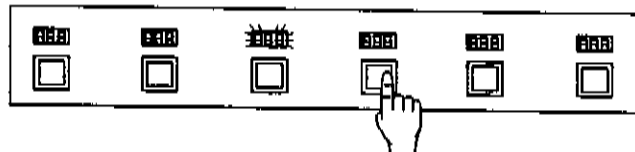

- 8) Press the UP or DOWN buttons on the customer display to advance the conveyor to the next shelf. Repeat the steps 5-7 for all shelves.

Example: If the first selection is to contain compartments 1 - 3, press the far left selection button and then the third selection button. The fourth display will begin blinking, indicating that compartment is available to be configured next.

NOTE: The entire shelf must be configured before proceeding to the next shelf. The shelf must be configured from left to right.

- 9) Press **NEXT** to exit the PRICE menu. The PRICE menu must be exited after configuring the shelves and then reentered before setting prices. **Prices cannot be set in the SHELF CONFIGURATION mode.**



NOTE: The conveyor motor is disabled until the entire shelf is configured.

Price Sched

The purpose of the PRICE SCHED is to select the active Price Schedule. (See section SET PRICE.)

There are three Price Schedules that may be activated manually or automatically by time and day. (See section AUTO PRICE MENU)



To select a price schedule:

- 1) Press the  key until "PRICE SCHED-N ACTIVE" is displayed on the message center. (Where N = 1, 2, 3 or AUTO N.)
- 2) Use the  or  key to select schedule "1", "2", "3", or "AUTO N". The schedule that is selected will determine what prices the machine will use in vend operation.
- 3) If "AUTO" is selected, the active schedule number (N) is determined by the active AUTOPRICE times (See section AUTOPRICE MENU) is displayed also. If no times have been set up or the AUTOPRICE schedules are disabled, Schedule 1 is used.

Set Price

The purpose of SET PRICE is to set each compartment to a specific price.





To set prices:

- 1) Press the  key until SET PRICE N-\$.XX" is displayed on the message center. (N = 1, 2, or 3, XX = .05 to 99.95.)
- 2) Use the  or  key to change the price displayed on the message center.
- 3) Press one of the buttons within the boundaries of the selection that you want to price. *For example, if you want to price the first selection, and that selection contains three compartments, press any of the three selection buttons in front of that selection. The price displayed on the message center will be copied to the horizontal price display corresponding to the selection priced.*
- 4) Repeat the steps above to set prices on all shelves.

Set Product Code

The purpose of SET PROD CODES is to assign product codes to each selection.

To set product codes:

- 1) Press the  key until the message center displays "SET PROD CODE - 0".
- 2) Use the  or  key to select the desired product code.
- 3) Press the selection button corresponding to the desired selection. If the selection contains more than one compartment press the far left selection button, the other displays will contain dashes.
- 4) To set a different product code simply change the product code with the  or  keys and repeat step 3 above. The product codes range from 0 to 99.

NOTE: The Service Mode cannot be exited until the Price Menu is exited using the NEXT key. Closing the service door will NOT place the vendor in vend mode, if the Price Menu has not been exited.







NOTE: Changing the physical position of the zero position shelf will affect the programmed configuration of the shelves. If the location of the zero position shelf is changed, prices and shelf configuration should be reprogrammed to avoid pricing errors.

MIS MENU

The MIS menu contains the menu items that handle the MIS data collected by the 550. This menu also contains the menu items used to empty, fill and calibrate the coin tubes.

Set Coin Tubes

The purpose of SET COIN TUBES is to empty, or fill the coin tubes to a desired level.



- 1) To empty the coin tubes:
 - a) Press the  key until "SET COIN TUBES-NONE" appears on the message center.
 - b) To empty the coin tubes completely, use the  or  keys until "SET COIN TUBES-EMPTY" is displayed on the message center.
 - c) Press the  key.
 - d) To stop emptying coins, press any key.
- 2) To fill the coin tubes from the side of the coin mechanism:
 - a) Use the  or  keys until "SET COIN TUBES - LOAD" is displayed on the message center.
 - b) Press the  key.

NOTE: If coins are loaded from the side of the coin mech, the number of coins added must be programmed using the **coins added** steps below.



- 3) Loading the coin tubes can also be performed by loading the coins through the top flight deck of the Coin Mech at any time during service mode.

NOTE: If coins are loaded from the top flight deck, the additions are automatically added to the coin tube totals and no further programming is necessary.



\$1 Coins Added

- 1) "\$1 COINS ADDED - 0" appears on the message center.
- 2) Use the  or  keys to display the number of dollar coins that are being added through the side of the coin tube.
- 3) Press the  key.



Quarters Added

- 1) "QUARTERS ADDED - 0" appears on the message center.
- 2) Use the  or  keys to display the number of quarters that are being added through the side of the coin tube.
- 3) Press the  key.

Dimes Added

- 1) "DIMES ADDED - 0" appears on the message center.
- 2) Use the  or  keys to display the number of dimes that are being added through the side of the coin tube.
- 3) Press the  key.

Nickels Added





- 1) "NICKELS ADDED - 0" appears on the message center.
- 2) Use the  or  keys to display the number of nickels that are being added through the side of the coin tube.
- 3) Press the  key.

NOTE:

If the "EMPTY" option is used, the coin amounts that the coin mech delivers are recorded in the BAG TOTAL. (See section BAG TOTAL.) If the "LOAD" option is used, the new coin totals will be reflected in the tube totals. (See sections COIN TOTAL, \$1 COINS, QUARTERS, DIMES, and NICKELS.)





Bill Accept Empty

The purpose of BILL ACCEPT EMPTY is to clear the bill tallies after the bill stacker is emptied. The bill tallies are added to the BAG TOTAL.

- 1) After the bill stacker is emptied, Press the  key until "BILL ACCEPT EMPTY - NO" appears on the message center.
- 2) Use the  or  keys, display "YES" on the message center.
- 3) Press the  key. (See section BAG TOTAL.)

Cash Box Empty



The purpose of CASH BOX EMPTY is to clear the cash box tallies after it is emptied. The cash box tallies are added to the BAG TOTAL.

- 1) After the cash box is emptied, Press the  key until "CASH BOX EMPTIED - NO" appears on the message center.
- 2) Use the  or  keys to display "YES" on the message center.
- 3) Press the  key. (See section BAG TOTAL.)

Print MIS

The PRINT MIS menu item sends the MIS data to the RS-232 port (if equipped) to be printed. All of the MIS menu data, the software version, time and date, machine ID, audit number and other pertinent information will be included. (See Sections CLOCK MENU, and SET MACHINE ID)

To send the MIS information:





- 1) Press the  key until "PRINT MIS DATA - NO" appears on the message center.
- 2) Use the  or  keys to display "YES" on the message center.

- 3) Press the  key.

Clear MIS Data

The purpose of CLEAR MIS DATA is to reset all MIS totals, except for the non-resettable information, to zero.

To clear the MIS information:

- 1) Press the  key until "CLEAR MIS DATA - NO" appears on the message center.
- 2) Use the  or  keys, display "YES" on the message center.
- 3) Press the  key. (See section MIS CLEAR COUNT.)

Sales (R)

The purpose of SALES (R) is to display the total amount of sales that the machine has made since the last initialization or MIS Reset. "SALES (R)-\$.XX" will appear on the message center, where XX is the dollar amount. When the amount exceeds \$99999.95 it will restart at \$.00 .

To display the resettable sales:

- 1) Press the  key until "SALES (R)-\$.XX" appears on the message center. (Where XX is the dollar amount.)

Sales (N)

The purpose of SALES (N) is to display the total amount of sales that the machine has made. It will never be reset. SALES (N)-\$.XX" will appear on the message center, where XX is the dollar amount. When the amount exceeds \$99999.95 it will restart at \$.00 .

To display the non-resettable sales:

- 1) Press the  key until "SALES (N)-\$.XX" appears on the message center. (Where XX is the dollar amount.)

Bag Total

The purpose of BAG TOTAL is to display the total amount of money that has been emptied from the coin mechanism, the bill acceptor and the coin box. When the amount exceeds \$99999.95 it will restart at \$.00 .

To display the bag total:

- 1) Press the  key until "BAG TOTAL-\$.XX" appears on the message center. (Where XX is the dollar amount.)

Cash Box

The purpose of CASH BOX is to display the total amount of money in the cash box. When the amount exceeds \$99999.95 it will restart at \$.00.

To display the cash box total:

- 1) Press the  key until "CASH BOX-\$.XX" appears on the message center. (Where XX is the dollar amount.)

Card Sales

The purpose of CARD SALES is to display the total amount of vend card sales (if equipped). When the amount exceeds \$99999.95 it will restart at \$.00.

To display the card sales:

- 1) Press the  key until "CARD SALES-\$.XX" appears on the message center. (Where XX is the dollar amount.)

Bill Total

The purpose of BILL TOTAL is to display the total value of the bills held in the bill stacker. When the amount of bills exceeds 999 it will restart at \$.00.

To display the bill total:

- 1) Press the  key until "BILL TOTAL-\$.XX" appears on the message center. (Where XX is the dollar amount.)

Ones

The purpose of ONES is to display the total number and value of one dollar bills held in the bill stacker. When the amount of bills exceeds 999 it will restart at 1.

To display the one dollar bill total:

- 1) Press the  key until "ONES-N \$.XX" appears on the message center. (Where N is the number of bills and XX is the dollar amount.)

Twos

The purpose of TWOS is to display the total number and value of two dollar bills held in the bill stacker. When the amount of bills exceeds 999 it will restart at 1.

To display the two dollar bill total:

- 1) Press the  key until "TWOS-N \$.XX" appears on the message center. (Where N is the number of bills and XX is the dollar amount.)

Fives

The purpose of FIVES is to display the total number and value of five dollar bills held in the bill stacker. When the amount of bills exceeds 999 it will restart at 1.

To display the five dollar bill total:

- 1) Press the  key until "FIVES-N \$.XX" appears on the message center. (Where N is the number of bills and XX is the dollar amount.)

Coin Total

The purpose of COIN TOTAL is to display the total value of the coins held in the coin tubes. When the amount of coins exceeds 999 it will restart at \$.00.

To display the coin total:

- 1) Press the  key until "COINS TOTAL-\$.XX" appears on the message center. (Where XX is the dollar amount.)

\$1 Coins

The purpose of \$1 COINS is to display the total number and value of \$1 coins held in the coin mech tubes.

To display the \$1 coin total:

- 1) Press the  key until "\$1 COINS-N \$.XX" appears on the message center. (Where N is the number of coins and XX is the dollar amount.)

Quarters

The purpose of QUARTERS is to display the total number and value of quarters held in the coin mech tubes.

To display the quarter coin total:

- 1) Press the **SET** key until "QUARTERS-N \$.XX" appears on the message center. (Where N is the number of coins and XX is the dollar amount.)

Dimes

The purpose of DIMES is to display the total number and value of dimes held in the coin mech tubes.

To display the dime coin total:

- 1) Press the **SET** key until "DIMES-N \$.XX" appears on the message center. (Where N is the number of coins and XX is the dollar amount.)

Nickels

The purpose of NICKELS is to display the total number and value of nickels held in the coin mech tubes.

To display the nickels coin total:

- 1) Press the **SET** key until "NICKELS-N \$.XX" appears on the message center. (Where N is the number of coins and XX is the dollar amount.)

Rand Vends-\$

The purpose of RAND VENDS-\$ is to display the total monetary amount of random free vends sales that have occurred. When the number of random free vends exceeds 9999, random free vend value will restart at \$.00.

To display the random vend monetary total:

- 1) Press the **SET** key until "RAND VEND-\$.XX" appears on the message center. (Where XX is the dollar amount.)

Free Vends-\$

The purpose of FREE VENDS is to display the total monetary amount of random free vends sales that have occurred. When the number of free vends exceeds 9999, free vend value will restart at \$.00.

To display the free vend monetary total:

- 1) Press the **SET** key until "FREE VEND-\$.XX" appears on the message center. (Where XX is the dollar amount.)

Disc 1- \$

The purpose of DISC 1 - \$ is to display the amount of money discounted from the scheduled prices while Discount 1 was active. When the number of Discount 1 exceeds 9999, the Discount 1 vend value will restart at \$.00.

To display the Discount 1 monetary total:

- 1) Press the **SET** key until "DISC 1 - \$.XX" appears on the message center. (Where XX is the dollar amount.)

Disc 2 - \$

The purpose of DISC 2 - \$ is to display the amount of money discounted from the scheduled prices while Discount 2 was active. When the number of Discount 2 exceeds 9999, the Discount 2 vend value will restart at \$.00.

To display the Discount 2 monetary total:

- 1) Press the **SET** key until "DISC 2 - \$.XX" appears on the message center. (Where XX is the dollar amount.)

Disc 3 - \$

The purpose of DISC 3 - \$ is to display the amount of money discounted from the scheduled prices while Discount 3 was active. When the number of Discount 3 exceeds 9999, the Discount 3 vend value will restart at \$.00.

To display the Discount 3 monetary total:

- 1) Press the **SET** key until "DISC 3 - \$.XX" appears on the message center. (Where XX is the dollar amount.)

Total Vends

The purpose of TOTAL VENDS is to display the total number of vends that have occurred. When the amount of total vends exceeds 9999 it will restart at 1.

To display the total number of vends:

- 1) Press the **SET** key until "TOTAL VENDS -N" appears on the message center. (Where N is the number of vends.)

Sched 1 Vends

The purpose of SCHED 1 VENDS is to display the total number of vends that have occurred while Schedule 1 prices were active. Schedule 1 is the default schedule. When the amount of Schedule 1 vends exceeds 9999 it will restart at 1.

To display the number of vends during Price Schedule 1:

- 1) Press the  key until "SCHED 1 VENDS - N" appears on the message center. (Where N is the number of vends.)

Sched 2 Vends

The purpose of SCHED 2 VENDS is to display the total number of vends that have occurred while Schedule 2 prices were active. When the amount of Schedule 2 vends exceeds 9999 it will restart at 1.

To display the number of vends during Price Schedule 2:

- 1) Press the  key until "SCHED 2 VENDS - N" appears on the message center. (Where N is the number of vends.)

Sched 3 Vends

The purpose of SCHED 3 VENDS is to display the total number of vends that have occurred while Schedule 3 prices were active. When the amount of Schedule 3 vends exceeds 9999 it will restart at 1.

To display the number of vends during Price Schedule 3:

- 1) Press the  key until "SCHED 3 VENDS - N" appears on the message center. (Where N is the number of vends.)

Random Vends

The purpose of RANDOM VENDS is to display the total number of random free vends that have occurred (See Section RNDM FREE VEND). When the amount of random vends exceeds 9999 it will restart at 1.

To display the total number of random free vends:

- 1) Press the  key until "RANDOM VENDS - N" appears on the message center. (Where N is the number of vends.)

Free Vends

The purpose of FREE VENDS is to display the total number of free vends that have occurred. When the amount of free vends exceeds 9999 it will restart at 1.

To display the total number of free vends:

- 1) Press the  key until "FREE VENDS - N" appears on the message center. (Where N is the number of vends.)

Disc 1 Vends

The purpose of DISC 1 VENDS is to display the total number of discounted vends while Discount 1 was active. When the amount of Discount 1 vends exceeds 9999 it will restart at 1.

To display the total number of vends while discount 1 was active:

- 1) Press the  key until "DISC 1 VENDS - N" appears on the message center. (Where N is the number of vends.)

Disc 2 Vends

The purpose of DISC 2 VENDS is to display the total number of discounted vends while Discount 2 was active. When the amount of Discount 2 vends exceeds 9999 it will restart at 1.

To display the total number of vends while discount 2 was active:

- 1) Press the  key until "DISC 2 VENDS - N" appears on the message center. (Where N is the number of vends.)

Disc 3 Vends

The purpose of DISC 3 VENDS is to display the total number of discounted vends while Discount 3 was active. When the amount of Discount 3 vends exceeds 9999 it will restart at 1.

To display the total number of vends while discount 3 was active:

- 1) Press the  key until "DISC 3 VENDS - N" appears on the message center. (Where N is the number of vends.)

MIS Clear Count

The purpose of MIS CLEAR COUNT is to display the number of times that the MIS has been cleared via the MIS CLEAR menu item or "FULL" machine initialization. (See sections CLEAR MIS DATA and MACHINE INIT.) This data is non-resettable.





To display the number of times the MIS has been cleared:

- 1) Press the  key until "MIS CLEAR COUNT-N" appears on the message center. (Where N is the number of clears.)

Power Losses

The purpose of POWER LOSSES is to display the last time and date that the machine lost power. If the machine has never lost power, "NOT APPLICABLE" will be displayed. This data is non-resettable.





To display the last time the machine lost power:

- 1) Press the  key until "POWER LOSSES - NO" appears on the message center.
- 2) By using the  or  keys, displaying "YES" on the message center and Pressing the  key, the last time, day and date the power to the machine had been off will appear.

Price Changed

The purpose of PRICE CHANGED is to display the last time and date that a price was changed. If the prices have never been changed, then "NOT APPLICABLE" will be displayed. This data is non-resettable.





To display the last time a price changed:

- 1) Press the  key until "PRICE CHANGED - NO" appears on the message center.
- 2) By using the  or  keys, displaying "YES" on the message center and Pressing the  key, the last time, day and date a price had changed will appear. (To set or change prices see section SET PRICE.)

Out of Service

The purpose of OUT OF SERVICE is to display the last time and date that the machine went out of service. If the machine has never gone out of service then "NOT APPLICABLE" will be displayed. This data is non-resettable.





To display the last time the machine went out of service:

- 1) Press the  key until "OUT OF SERVICE - NO" appears on the message center.
- 2) By using the  or  keys, displaying "YES" on the message center and pressing the  key, the last time, day and date that the machine went out of service will appear.

Time Over Health

The purpose of Time Over Health is to display the amount of time the temperature of the refrigerated compartment has been over the health control threshold. If the compartment has not exceeded the health control threshold after the pull down period "NOT APPLICABLE" will be displayed. Otherwise, the length of time the compartment has been over the health control threshold and the maximum temperature that the compartment has attained will be displayed.

To display the TIME OVER HEALTH:

- 1) Press the  key until "TIME OVER HEALTH - NO" appears on the message center.
- 2) Use the  or  keys to display "YES"
- 3) Press the  key.
- 4) "HH.MM.SS XX F MAX" will appear on the message center. If the temperature in the refrigerated compartment did not exceed the maximum health temperature then "NOT APPLICABLE" will appear on the message center. (Where HH is hours, MM is minutes, SS is seconds, and XX is degrees Fahrenheit)





Max Temperature

The purpose of MAX TEMPERATURE is to allow the operator to display the maximum temperature that the refrigerated compartment has achieved after the machine has reached the pull down temperature.

The message center will display the maximum temperature along with the date and time the maximum temperature was achieved.

If the temperature inside the refrigerated compartment has not reached the pull down temperature then "MIN TEMP NOT REACHED" will appear on the message center.

To display the maximum temperature:

- 1) Press the  key until "MAX TEMPERATURE-NO" appears on the message center.
- 2) Use the  or  keys to display "YES"
- 3) Press the  key. TTF MM/DD/YY HH.NNXM will appear on the message center. (Where TT is the maximum temperature in Fahrenheit, MM is the month, DD is the day, YY is the year, HH is the hour, NN is the minute, and XM is either AM or PM.) If the temperature inside the refrigerated compartment has not reached the pull down temperature then "MIN TEMP NOT REACHED" will appear on the message center.

Min Temperature





The purpose of MIN TEMPERATURE is to allow the operator to display the minimum temperature that the refrigerated compartment has achieved after the machine has reached the pull down temperature.

The message center will display the minimum temperature along with the date and time the minimum temperature was achieved.

If the temperature inside the refrigerated compartment has not reached the pull down temperature then "MIN TEMP NOT REACHED"

will appear on the message center.





To display the minimum temperature:

- 1) Press the  key until "MIN TEMPERATURE-NO" appears on the message center.
- 2) Use the  or  keys to display "YES"
- 3) Press the  key. TTF MM/DD/YY HH.NNXM will appear on the message center. (Where TT is the minimum temperature in Fahrenheit, MM is the month, DD is the day, YY is the year, HH is the hour, NN is the minute, and XM is either for AM or PM.) If the temperature inside the refrigerated compartment has not reached the pull down temperature, "MIN TEMP NOT REACHED" will appear on the message center.

Clock Changes

The purpose of CLOCK CHANGES is to display the number of times the clock has been changed. If the clock has never been changed then "NOT APPLICABLE" will be displayed. This data is non-resettable.

To display the number of times the clock has been changed:

- 1) Press the  key until "CLOCK CHANGES - NO" appears on the message center.
- 2) By using the  or  keys, displaying "YES" on the message center and pressing the  key, "TIMES CHANGED - N" will appear. (Where N is the number of times the clock has changed. To change or set the date, time, or day see section SET DATE, SET TIME, or SET DAY.)

NOTE:

Pressing the  key at any time will advance to the next menu. All changes that have been set will automatically be saved.

OPTIONS MENU

The OPTIONS menu contains the menu items that select the Multiview, Forced Vend, Free Vend, Random Free Vend, Display Time and Price Display options. In this menu the Bill Acceptor can be enabled, the language selected and the Security Code, Machine ID and Point of Sale Message programmed.

Multiview

The purpose of MULTIVIEW is to rotate the conveyor three shelves every three minutes. The conveyor will not rotate if there is credit pending in the machine or if a vend or conveyor rotation had occurred 15 seconds prior to the scheduled MULTIVIEW rotation.





If MULTIVIEW is selected, the active time period must be specified. A time period is described by setting start/stop times on specific days.

For example: If MULTIVIEW should be in effect from 9:00AM to 5:00PM on Monday through Friday, set the START TIME to 9:00AM, the STOP TIME to 5:00PM, the START DAY to MONDAY and the END DAY to FRIDAY.

To describe a complete 24 hour time period, set the START TIME to some time, 9:00AM for example. Then set the END TIME to 1 minute less than that time, 8:59AM in this case.

To describe a complete week, set the START DAY to some day, Monday for example. Then set the ENDDAY to the previous day, Sunday in this case.

To use the MULTIVIEW option:

- 1) Press the  key until "MULTIVIEW - OFF" appears on the message center. Use the  or  keys to display "ON".
- 2) Press the  key.



START TIME

"START TIME - HH.MM XM" will appear on the message center. This is the time of day that MULTIVIEW will become active. To continue, Press the  key.

Set Start Time

"SET START TIME - NO" appears on the message center.



To set the start time:

- 1) Use the  or  keys to display "YES" on the message center.
- 2) Press the  key.

Set Hours



“SET HOURS - HH XM” will appear on the message center.

To change the hour:

- 1) Use the  or  keys to display the correct hour.
- 2) Press the  key.

Set Mins

“SET MINS - MM” will appear on the message center.

- 1) Use the  or  keys to display the correct minutes.
- 2) Press the  key.



STOP TIME

“STOP TIME - HH.MM XM” will appear on the message center. This shows the time of day that MULTIVIEW will become inactive. To continue, Press the  key.

Set Stop Time

“SET STOP TIME - NO” appears on the message center.



To set the stop time:

- 1) Use the  or  keys to display “YES” on the message center
- 2) Press the  key.

Set Hours

“SET HOURS - HH XM” will appear on the message center.



To change the hour:

- 1) Use the  or  keys to display the correct hour.
- 2) Press the  key.

Set Mins

“SET MINS - MM” will appear on the message center.

To change the minutes:

- 1) Use the  or  keys to display the correct minutes
- 2) Press the  key.



START DAY

“START DAY-WWWDAY” will appear on the message center. This shows the day of the week that MULTIVIEW will become active. To continue, Press the  key.

Set Start Day



“SET START DAY-NO” appears on the message center.

To set the start day:

- 1) Use the  or  keys to display “YES” on the message center.
- 2) Press the  key.

Set Day

“SET DAY - WWWDAY” will appear on the message center.

To change the day use the  or  keys to display the day.

- 2) Press the  key.



END DAY

“END DAY-WWWDAY” will appear on the message center. This shows the day of the week that MULTIVIEW will become inactive. To continue, Press the  key.

Set End Day

“SET END DAY-NO” appears on the message center.

To set the end day:

- 1) Use the  or  keys to display “YES” on the message center.
- 2) Press the  key.

Set Day

"SET DAY - WWWDAY" will appear on the message center.

To change the day:

- 1) Use the  or  keys to display the day.
- 2) Press the  key.





NOTE:

HH is hours, MM is minutes, XM is AM or PM, and WWW is the day of the week, i.e. SUN, MON, TUES, etc.)

Forced Vend

The purpose of FORCED VEND is to prevent the 550 from being used as a change machine. If credit is established in vend mode and the coin return is pressed, "MUST MAKE SELECTION" is displayed if the FORCED VEND option is active. FORCED VEND OFF is the default.





To set the FORCED VEND option:

- 1) Press the  key until "FORCED VEND - OFF" appears on the message center.
- 2) Use the  or  keys to display "ON".
- 3) Press the  key.

Bill Acceptor

The purpose of BILL ACCEPTOR is to enable the bill acceptor and define the type of bills that the bill acceptor will accept.



To enable the bill acceptor:

- 1) Press the  key until "BILL ACCEPTOR - OFF" appears on the message center.
- 2) Use the  or  keys to display "ON".
- 3) Press the  key.

\$1 Bills

"\$1 BILLS - REJECT" will appear on the message center.



To accept one dollar bills:

- 1) Use the  or  keys to display "ACCEPT".
- 2) Press the  key.

\$2 Bills

"\$2 BILLS - REJECT" will appear on the message center.



To accept two dollar bills:

- 1) Use the  or  keys to display "ACCEPT".
- 2) Press the  key.

\$5 Bills

"\$5 BILLS - REJECT" will appear on the message center.





To accept five dollar bills:

- 1) Use the  or  keys to display "ACCEPT".
- 2) Press the  key.

Free Vend

The purpose of FREE VEND is to put the machine in free vend mode. When this option is active, the price display will show .00, and "MAKE FREE SELECTION" will be displayed in Vend Mode unless a point of sale message is invoked. (See section SET MESSAGE.)

To use the FREE VEND option:

- 1) Press the  key until "FREE VEND - OFF" appears on the message center.
- 2) Use the  or  keys to display "ON".
- 3) Press the  key.

Random Free Vend

The purpose of RNDM FREE VEND is to randomly give a free vend. The occurrence of a free vend can be set from 1 in 50 to 1 in 3000. When a random free vend occurs, the vend price will be returned and the message center will display "YOU ARE A WINNER".

To use the RNDM FREE VEND option:

- 1) Press the **SET** key until "RNDM FREE VEND - OFF" appears on the message center.
- 2) Use the **▲** or **▼** arrow keys to display "ON".
- 3) Press the **SET** key.

Odds

"ODDS - 1 IN N" will appear on the message center.

To increment or decrement the odds:

- 1) Use the **▲** or **▼** keys.
- 2) Press the **SET** key. (N = 50 to 3000.)

Display Time

The purpose of DISPLAY TIME is to display the time, day and date on the message center while in vend mode, providing that no point of sale message is active, the machine is not OUT OF SERVICE, and the machine is not in EXACT CHANGE MODE.

To use the DISPLAY TIME option:

- 1) Press the **SET** key until "DISPLAY TIME - OFF" appears on the message center.
- 2) Use the **▲** or **▼** keys to display "ON"
- 3) Press the **SET** key.

Set Machine ID

The purpose of SET MACHINE ID is to set a machine ID of up to 12 letters, numbers, or characters.

To set the MACHINE ID:

- 1) Press the **SET** key until "SET MACHINE ID - NO" appears on the message center.
- 2) Use the **▲** or **▼** keys to display "YES"
- 3) Press the **SET** key.
- 4) "MACH ID- _____" will appear on the screen.
- 5) Use the **▲** or **▼** keys to change the character that is being displayed.

- 6) When the desired character is displayed press the **SET** key.
- 7) The flashing " ^ " character signifies the current character.
- 8) If less than 12 characters, use the end bracket "] " to signify the end of message routine.
- 9) When all the characters in the ID are set or an end bracket character is used, the message center will again display "SET MACHINE ID - NO".
- 10) Press the **SET** key for the next menu item.

Security Code

The purpose of the SECURITY CODE option, is to prevent access to specific menus.

If the security code option is active, the operator cannot gain full access to the service menu without first entering the correct security code. Menus can be locked out, preventing access to certain machine functions and settings.

For example: If the Options menu is restricted and the security feature is disabled for all other menus, an operator without the security code, will be able to access all of the machine's functions, except those located in the Options menu.

When the security code option is active, "SECURITY CODE - ____" will be displayed in the Service Mode after clearing all error messages (if applicable).

The operator must then enter the security code. If the code is correct, "FULL ACCESS GRANTED" will be temporarily displayed and all the service menus are available. If the code is incorrect, only the menus listed above will be available.

To enter the service mode without entering the security code, press the <NEXT> key when prompted to enter the security code. Access will be granted to non-restricted menus.

To set the SECURITY CODE:

- 1) Press the **SET** key until "SECURITY CODE - OFF" appears on the message center.
- 2) Use the **▲** or **▼** keys to display "ON"
- 3) Press the **EDIT** key. "EDIT SEC CODE - NO" appears on the message center.
- 4) Use the **▲** or **▼** arrow keys to display "YES" and Press the **SET** key.
- 5) "SECURITY CODE ____" will appear on the screen.
- 6) Use the **▲** or **▼** keys to change the character that is being displayed.
- 7) When the desired character is displayed Press the **SET** key.
- 8) The flashing "^" character signifies the current character. If the code is less than 4 characters use the end bracket "]" to signify the end of the message routine.
- 9) When all the characters in the security code are set or an end bracket character is used, the message center will again display "EDIT SEC CODE - NO".
- 10) Depress the **SET** key for the next menu item.

Select Menus

The select menus option is used to select the menus that will be restricted while the security feature is active.

- 1) Press the **SET** key until "SELECT MENUS - NO" appears on the message center.
- 2) Use the **▲** or **▼** keys to display "YES"
- 3) Press the **EDIT** key. "PRICEMENU-NO" appears on the message center.
- 4) Use the **▲** or **▼** arrow keys to toggle "YES / NO" and press the **SET** key. Selecting "YES" will restrict this menu when the security feature is enabled. Selecting "NO" will allow access without entering the security code.
- 5) Repeat step 5 for each of the menus.

Set Message

The SET MESSAGE option is used to set a user definable Point of Sale Message.

The Point of Sale Message may be a fixed length message, which can be up to 20 characters long or a scrolling message, which can be up to 250 characters long. Either type of message will be displayed on the message center provided that the machine is in Vend Mode, not OUT OF SERVICE, and not in EXACT CHANGE MODE.

To set the Point of Sale Message:

- 1) Press the **SET** key until "SET MESSAGE - OFF" appears on the message center.
- 2) Use the **▲** or **▼** keys to display "FIXED" or "SCROLL"
- 3) Press the **EDIT** key.
- 4) "EDIT MESSAGE - NO" will appear on the Message Center.
- 5) Use the **▲** or **▼** keys to display "YES".
- 6) Press the **SET** key. " _____ " will appear on the screen.
- 7) Use the **▲** or **▼** keys to change the character that is being displayed.
- 8) When the desired character is displayed press the **SET** key.
- 9) The flashing "^" character signifies the current character. The end bracket "]" signifies the end of message character.
- 10) When all the characters in the message are set or an end bracket character is used, the message center will again display "SET MESSAGE - NO".
- 11) Depress the **SET** key for the next menu item.

Price Display

The purpose of PRICE DISPLAY is to eliminate the "Sold" messages on the column display when a compartment has been sold.

If PRICE DISPLAY-PRICE is selected, the display will continue to display the price of each sold compartment. If "PRICE DISPLAY-SOLD" is set,

then "Sold" will be displayed for each sold compartment. In either case, each compartment can only be sold one time. "ITEM PREVIOUSLY SOLD" will be displayed on the message center when attempting to open a sold compartment.

To set the price display after a vend:

- 1) Press the **SET** key until "PRICE DISPLAY-SOLD" is displayed on the message center.
- 2) Use the **UP** or **DOWN** keys to display "PRICE".
- 3) Press the **SET** key for the price to be displayed after a vend, otherwise Press the **NEXT** key for the next menu item. (The default is "Sold".)

Prohibit Vending

The purpose of PROHIBIT VENDING is to allow the operator to put the machine OUT OF SERVICE without an error. When the service door is closed, the machine will be out of service, but there will be no error messages shown when service mode is entered.

To set the machine out of order:

- 1) Press the **SET** key until "PROHIBIT VENDING-NO" is displayed on the message center.
- 2) Use the **UP** or **DOWN** arrow keys to display "YES".
- 3) Press the **SET** key.

Language

The purpose of LANGUAGE is to allow the operator to display the vend message in either "ENGLISH", "FRENCH", or "SPANISH". The default language is English.

To set the vend messages to a language:

- 1) Press the **SET** key until "LANGUAGE - ENGLISH" appears on the message center.
- 2) Use the **UP** or **DOWN** keys to display either "ENGLISH", "FRENCH", or "SPANISH"
- 3) Press the **SET** key.

NOTE:

Pressing the **NEXT key at any time will advance to the following menu. All changes that have been set will automatically be saved.**

CLOCK MENU

The CLOCK menu contains the menu items that set the internal clock.



DATE

"DATE - MM/DD/YY" will appear on the message center. This shows the current date. To continue, press the  key.

Set Date

"SET DATE - NO" appears on the message center.



To change the date:

- 1) Use the  or  keys to display "YES" on the message center.
- 2) Press the  key.

Set Day of Month

"SET DAY OF MONTH - DD" will appear on the message center.



To change the day of the month:

- 1) Use the  or  keys to display the day of the month.
- 2) Press the  key.

Set Month

"SET MONTH - MM" will appear on the message center.



To change the month:

- 1) Use the  or  keys to display the correct month
- 2) Press the  key.

Set Year

"SET YEAR - YY" will appear on the message center.

To change the year:

- 1) Use the  or  keys to display the correct year
- 2) Press the  key.



TIME

"TIME - HH.MM XM WWW" will appear on the message center. This is the current time. To continue, press the  key.

Set Time

"SET TIME - NO" appears on the message center.



To change the time:

- 1) Use the  or  keys to display "YES" on the message center.
- 2) Press the  key.

Set Hours

"SET HOURS - HH XM" will appear on the message center.



To change the hour:

- 1) Use the  or  keys to display the correct hour.
- 2) Press the  key.

Set Mins

"SET MINS - MM" will appear on the message center.

To change the minutes:

- 1) Use the  or  keys to display the correct minutes.
- 2) Press the  key.

Set Day

"SETDAY - WWWDAY" will appear on the message center.

To change the day:

- 1) Use the  or  keys to display the day.
- 2) Press the  key.

CONVEYOR MENU

The CONVEYOR MENU is used to reserve shelves for vending at a later time.





CONVEYOR DELAY

The purpose of CONVEYOR DELAY is prohibit vending in certain shelves. Shelves 6-16 may be reserved until a later time.

If CONVEYOR DELAY is active and the conveyor is rotated into a reserved section, the machine will continue to rotate into the first vendible section, the message center will display "RESERVED SECTION" and the price display will show "--" in place of the prices.



When the delay end time has been reached, the delay is disabled until the machine is refilled. Conveyor delay is active for only 24 hours. It must be reset every 24 hours.

To use the CONVEYOR DELAY option:

- 1) Press the  key until "CONVEYOR DELAY - OFF" appears on the message center.
- 2) Use the  or  keys to display "ON"
- 3) Press the  key.

Delay Sections

"DELAY SHELVES N - 16" will appear on the message center, where N is the starting "locked out" section, that is reserved for later vending.

- 1) Use the  or  keys to display the desired starting reserved shelf. Shelves 6-16 can be locked out.
- 2) Press the  key.



Stop Time

"STOP TIME - HH.MM XM" will appear on the message center. This is the time of day that the conveyor delay will end. To continue, press the  key.

Set Stop Time

"SET STOP TIME - NO" appears on the message center.



To change stop time:

- 1) Use the  or  keys to display "YES" on the message center.
- 2) Press the  key.

Set Hours

"SET HOURS - HH XM" will appear on the message center.



To change the hour:

- 1) Use the  or  keys to display the correct hour.
- 2) Press the  key.

Set Mins

"SET MINS - MM" will appear on the message center.

To change the minutes:

- 1) Use the  or  keys to display the correct minutes
- 2) Press the  key.

AUTO PRICE MENU

The AUTO PRICE menu contains the menu items that set the time periods during which the different price schedules will become active when AUTO PRICE is enabled.

A time period is described by start and end times between and including the start and end days. For example, if price schedule 2 should be in effect from 9:00AM to 5:00PM on Monday through Friday, set the START TIME to 9:00AM, the STOP TIME to 5:00PM, the START DAY to MONDAY and the END DAY to FRIDAY.

To describe a complete 24 hour time period, Choose a START TIME, 9:00AM for example. Set the END TIME to 1 minute less than that time, 8:59AM in this case.

To describe a complete week time period, choose a START DAY, Monday for example. Set the END DAY to the previous day, Sunday in this case. Setting the prices in the schedules is done in the PRICE MENU.





NOTE:

In order to activate a AUTO PRICE Schedule, the PRICE SCHED-AUTO N in the PRICE MENU must be selected after setting the time periods (See section PRICE SCHED-N ACTIVE)

ENABLE SCHED N

The purpose of ENABLE SCHED N is to set the time period that price schedule N will be active.

To enable schedule N:

- 1) Press the  key until "ENABLE SCHED N - NO" appears on the message center.
- 2) Use the  or  keys to display "YES"
- 3) Press the  key.



START TIME

"START TIME - HH.MM XM" will appear on the message center. This shows the time of day that the schedule N prices will become active. To continue, press the  key.

Set Start Time

"SET START TIME - NO" appears on the message center.



To set the start time:

- 1) Use the  or  keys to display "YES" on the message center.
- 2) Press the  key.

Set Hours

“SET HOURS - HH XM” will appear on the message center.



To change the hour:

- 1) Use the  or  keys to display the correct hour
- 2) Press the  key.

Set Mins

“SET MINS - MM” will appear on the message center.

To change the minutes:

- 1) Use the  or  keys to display the correct minutes
- 2) Press the  key.



STOP TIME

“STOP TIME - HH.MM XM” will appear on the message center. This shows the time of day that the schedule N prices will become inactive. To continue, Press the  key.

Set Stop Time

“SET STOP TIME - NO” appears on the message center.



To set the stop time:

- 1) Use the  or  keys to display “YES” on the message center.
- 2) Press the  key.

Set Hours

“SET HOURS - HH XM” will appear on the message center.

To change the hour:

- 1) Use the  or  keys to display the correct hour
- 2) Press the  key.

Set Mins

“SET MINS - MM” will appear on the message center.

To change the minutes:

- 1) Use the  or  keys to display the correct minutes.

- 2) Press the  key.



START DAY

“START DAY-WWWDAY” will appear on the message center. This shows the day of the week that the schedule N prices will become active. To continue, press the  key.

Set Start Day

“SET START DAY-NO” appears on the message center.



To set the start day:

- 1) Use the  or  keys to display “YES” on the message center.
- 2) Press the  key.

Set Day

“SET DAY - WWWDAY” will appear on the message center.

To change the day:

- 1) Use the  or  keys to display the day.
- 2) Press the  key.



END DAY

“END DAY-WWWDAY” will appear on the message center. This shows the day of the week that the schedule N prices will become inactive. To continue, press the  key.

Set End Day

“SET END DAY-NO” appears on the message center.

To set the end day:

- 1) Use the  or  keys to display “YES” on the message center.
- 2) Press the  key.

Set Day

“SET DAY - WWWDAY” will appear on the message center.

To change the day:

- 1) Use the  or  keys to display the day.
- 2) Press the  key.

DISCOUNT MENU

The DISCOUNT menu contains the menu items that set the time periods during which the discounts will become active.

A time period is described by start and end times between and including the start and end days.

For example: If a discount is desired from 9:00AM to 5:00PM on Monday through Friday, set the START TIME to 9:00AM, the STOP TIME to 5:00PM, the START DAY to MONDAY and the END DAY to FRIDAY.





To describe a complete 24 hour time period, choose a START TIME, 9:00AM for example. Set the END TIME to 1 minute less than that time, 8:59AM in this case.

To describe a complete week time period, choose a START DAY, Monday for example. Set the END DAY to the previous day, Sunday in this case.

SET DISCOUNT N

The purpose of SET DISCOUNT N is to set the time period that DISCOUNT N will be active.

To enable DISCOUNT N:

- 1) Press the  key until "SET DISCOUNT N-NO" appears on the message center.
- 2) Use the  or  keys to display "YES".
- 2) Press the  key.



Discount

This menu item sets the amount that will be deducted from all prices in the active schedule when the discount is active.

If the discount is greater than or equal to the price of an item, the price will become \$.00.

To set the DISCOUNT:

- 1) Press the  key until "DISCOUNT - \$.XX" is displayed on the message center. (XX = .05 to 99.95.)

- 2) Use the  or  key to select the desired discount.
- 3) Press the  key.



START TIME

"START TIME - HH.MM XM" will appear on the message center. This shows the time of day that Discount N will become active. To continue, Press the  key.

Set Start Time



"SET START TIME - NO" appears on the message center.

To set the start time:

- 1) Use the  or  keys to display "YES" on the message center
- 2) Press the  key.

Set Hours



“SET HOURS - HH XM” will appear on the message center.

- 1) To change the hour, use the  or  keys to display the correct hour.
- 2) Press the  key.

Set Mins

“SET MINS - MM” will appear on the message center.

To change the minutes:

- 1) Use the  or  keys to display the correct minutes.
- 2) Press the  key.



STOP TIME

“STOP TIME - HH.MM XM” will appear on the message center. This shows the time of day that Discount N will become inactive. To continue, press the  key.

Set Stop Time



“SET STOP TIME - NO” appears on the message center.

To set the stop time:

- 1) Use the  or  keys to display “YES” on the message center.
- 2) Press the  key.

Set Hours

“SET HOURS - HH XM” will appear on the message center.

To change the hour, use the  or  keys to display the correct hour.

- 2) Press the  key.

Set Mins

“SET MINS - MM” will appear on the message center.

To change the minutes:

- 1) Use the  or  keys to display the correct minutes

- 2) Press the  key.



START DAY

“START DAY-WWWDAY” will appear on the message center. This shows the day of the week that Discount N will become active. To continue, press the  key.

Set Start Day

“SET START DAY-NO” appears on the message center.



To set the start day:

- 1) Use the  or  keys to display “YES” on the message center.
- 2) Press the  key.

Set Day

“SET DAY - WWWDAY” will appear on the message center.

To change the day:

- 1) Use the  or  keys to display the day
- 2) Press the  key.



End Day

“END DAY-WWWDAY” will appear on the message center. This shows the day of the week that Discount N will become inactive. To continue, press the  key.

Set End Day

“SET END DAY-NO” appears on the message center.

To set the end day:

- 1) Use the  or  keys to display “YES” on the message center.
- 2) Press the  key.

SET DAY

“SET DAY - WWWDAY” will appear on the message center.

To change the day:

- 1) Use the  or  keys to display the day.
- 2) Press the  key.

DIAGNOSTICS





MENU

The DIAGNOSTICS menu contains the menu items that perform system diagnostics.

Health Test

The purpose of the HEALTH TEST is to test the health control feature.

To perform a HEALTH TEST:

- 1) Open the service door and the large main door.
- 2) Locate the temperature probe on the inside top portion of the main door.
- 3) Place a hand on the probe to raise the temperature above 45° F.
- 4) Check the temperature by pressing the blank key next to the  key.
- 5) The message center will temporarily display the "TEMPERATURE = XX F", where XX is the temperature being read by the probe.
- 6) When the temperature rises above 45° F, close the main door.
- 7) The display will read "HEALTH TEST - NO"
- 8) Use the  or  arrow keys to display "YES".
- 9) Press the  key.
- 10) Close the Service door.
- 11) Wait approximately 20 seconds for the machine to go out of service.

Card Credit

The purpose of the CARD CREDIT menu item is to test the Debit Card System (if installed).

The CARD CREDIT menu item shows the amount of Debit Card credit currently established when a Debit Card is inserted into the Debit Card reader.







The machine will accept as much credit as the debit card system is programmed to transfer.

Depress the escrow return button on the Debit Card System to return the credit to the card. The CARD CREDIT display should then return to "CARD CREDIT - \$.00".

Baffle Test

The purpose of baffle test is to test the operation of the baffles.



To perform the baffle test:

- 1) Use the  or  arrow keys to select SINGLE or ALL DOWN.
- 2) If ALL DOWN is selected all of the baffles will lower.
- 3) Press the  key. The baffles will lower and the display will read ALL BAFFLES DOWN.
- 4) If SINGLE is selected each baffle is lowered individually by pressing the selection button below it.
- 5) Press the  key. Display will read Select Baffle
- 6) Use the  or  keys to select RESET to reset the solenoids.

Set Zero Pos

The purpose of the SET ZERO POSITION menu item is to locate the zero position on the turret.

To locate zero pos:

- 1) Use the  or  arrow keys to display "YES"
- 2) Press the  key.
- 3) The message center will then display "TURN UNTIL ZERO POS" unless the turret is already located on the zero position switch.
- 4) If the turret is not on the zero position switch, turn the turret by depressing the <UP> or <DOWN> key until the "TURN UNTIL ZERO POS" message disappears from the message center.

NOTE: Changing the physical position of the zero position shelf will affect the programmed configuration of the shelves. If the location of the zero position shelf is changed, prices and shelf configuration should be reprogrammed to avoid pricing errors.

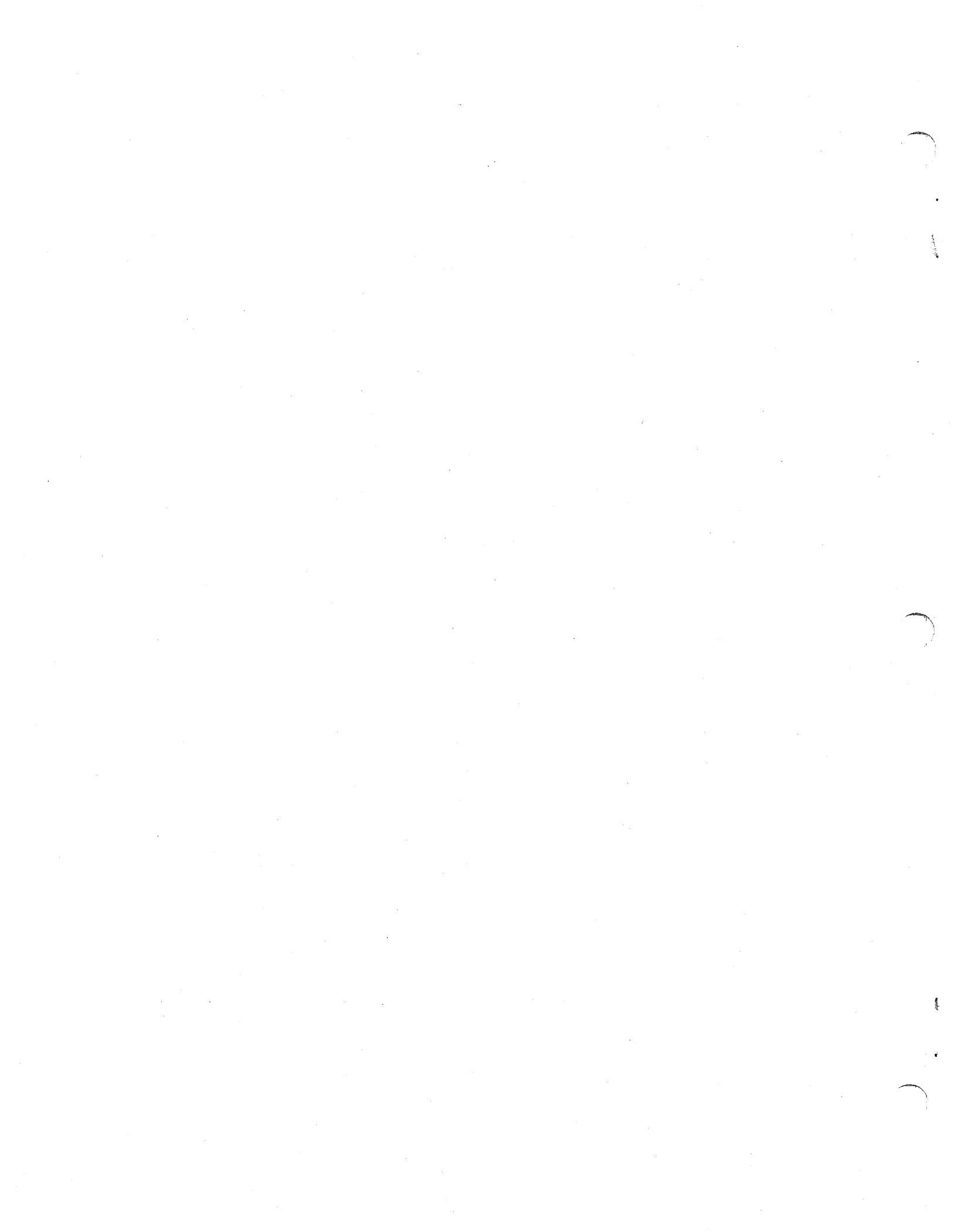

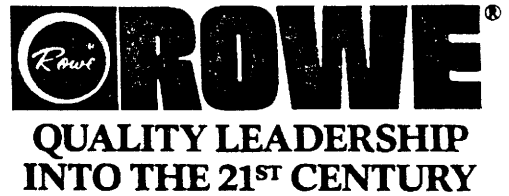

550 General Merchandiser

**Field Service Manual
and
Parts Catalog**

This manual contains all of the information necessary to install, operate, troubleshoot & perform basic maintenance on the all new 550 General Merchandiser. This manual contains an illustrated parts catalog that can be used to identify parts available for purchase from Rowe. Keep a copy of this manual with the vendor at all times for reference.

Part Number 900-55000 C
Third Edition
First Printing November, 1994
Printed in U.S.A

TABLE OF CONTENTS

SPECIFICATIONS	ii	SECTION 5 - MAINTENANCE	
HOW TO USE THIS MANUAL	iii	Shelf Removal	5-1
COIN MECH USAGE CHART	iv	Drive Assembly Adjustment	5-2
FEATURES	v	Drive Chain Tension Adjustment	5-3
SECTION 1 - INSTALLATION		Replacing Solenoids	5-4
Unpacking	1-1	Baffle Assembly Removal	5-5
Set-up Instructions	1-1	Baffle Assembly Adjustment	5-6
Pre-operation Check	1-3	Change Fluorescent Light	5-7
SECTION 2 - DESCRIPTION		SECTION 6 - PARTS CATALOG	
Main Component Operation	2-2	Table of Contents	6-1
Point of Sale Messages	2-10		
Health Control	2-11		
SECTION 3 - PROGRAM OPERATION			
Introduction	3-3		
Blind Operator Feature	3-3		
Basic Program Set-Up	3-4		
Security Code	3-4		
Quick-Reference Guide	3-5		
Price Menu	3-10		
MIS Menu	3-12		
Options Menu	3-19		
Clock Menu	3-25		
Conveyor Menu	3-26		
Auto Price Menu	3-27		
Discount Menu	3-29		
Diagnostics Menu	3-31		
Default Menu	3-33		
SECTION 4 - TROUBLESHOOTING			
Checklist	4-3		
Troubleshooting Charts			
Error Message	4-6		
Problem/Solution	4-8		
Universal Control Board Schematic	4-12		
Power Supply Schematic	4-16		
Vendor Wiring Diagram	4-20		

SPECIFICATIONS:

550 General Merchandiser

GENERAL

Depth	30 in.
Width	44 in.
Height	72 in.
Net Weight	800 lb.
Shipping Weight	825 lb.
Power Requirements	120 VAC, 15 AMPS MAX. 60 HERTZ ¹
Maximum Location Ambient Temperature	110° F

VEND CAPACITY

Total Items	96 MAX.
Number of Shelves	16
Delivery Doors	6
Delivery Door Dimensions	4"
Compartment Depth (Nominal)	7"
Number of compartments per shelf:	1 - 6 (Any combination)

OPERATING TEMPERATURES

Food Compartment	38° ± 4 ^{o2}
Ambient	Room Temperature

COIN MECHANISMS

120 VPDC Models-12 or 15 Pin	
MARS	TRC - 6000
COINCO	9300L
24 VPDC Models-15 Pin Only	
MARS	TRC - 6010 - XV
COINCO	9302LF

European	
MARS	MS1900 Executive MS1700 Executive MS1600 Executive

CAUTION !
Do not use 24 volt Coin Mech with 12 pin plugs! This will result in permanent damage to the Coin Mech and/or vending machine.

REFRIGERATION

Charge	R-134A - 21oz.
High Side	@ 75° F. 165-170psi
Low Side	@ 75° F. 20-25psi

¹ Ambient machines require 120 VAC, 6 AMPS 60 HERTZ.

² Refrigerated units

HOW TO USE THIS MANUAL

This manual contains six sections. The front section contains a table of contents and machine specifications. Described below is a brief outline of the numbered sections and the information discussed there.

SECTION 1 - INSTALLATION - Section 1 contains unpacking and set-up instructions. This section describes how to initialize the machine, load the coin mechanism and perform a pre-operation check. Use this section to install and check out the vendor.

SECTION 2 - DESCRIPTION - Section 2 contains a general introduction to the 550 General Merchandiser. It provides descriptions of the major components and features of the machine and a listing of point of sale messages. Before attempting to unpack or install this vendor, read and familiarize yourself with this section and Section 1 - Installation.

SECTION 3 - PROGRAM OPERATION - Section 3 contains detailed programming information and instructions necessary to perform all of the Service Mode operations. This section will explain how to set prices and product codes and configure the product shelves. It provides a detailed explanation of MIS features and operations.

SECTION 4 - TROUBLESHOOTING - Section 4 contains troubleshooting procedures, Error Message and Problem/Solution Troubleshooting Charts. Schematics for the main controller, power supply, and a vendor wiring diagram are also located in this section. Use this in conjunction with the information in Section 5 - Maintenance, to isolate and repair vendor malfunctions.

SECTION 5 - MAINTENANCE - Section 5 contains instructions for cleaning, adjusting, repairing and replacing components on the 550 General Merchandiser. Adjustment, repair and replacement procedures should be performed only as required. Isolate equipment trouble using the information and diagrams in Section 4 before attempting to make adjustments or replace parts.

SECTION 6 - PARTS CATALOG - Section 6 contains a view of each assembly with part and section called out. Part numbers under a four digit assembly number are indented to the right if they are shipped as a group when ordering the assembly number. If they are not indented they must be ordered individually.

COIN MECH. CHART

ROWE VENDING MACHINE COIN MECH USAGE													
Coin Acceptors	406					425			448 E2	505	548	550	5900
	6 PUMP		8 PUMP			W.A.D	WO/BA	W/BA	W.A.D				
Coinco	WO/BA	W/BA	WO/BA	W/BA									
9300S <small>Single Price \$12.75 Max 120 VAC</small>	X		X			X							
9340S <small>Single Price \$12.75 Max 120 VAC</small>	X	X	X	X		X	X						
9360S <small>Single Price \$12.75 Max 120 VAC</small>	X	X	X	X		X	X						
S75-9800B-907 <small>Single Price \$3.15 Max 120 VAC</small>	X		X			X							
S75-9400B-977 <small>Single Price \$1.15 Max 120 VAC</small>	X		X			X							
F300E-9210 <small>Four Price \$3.15 Max 120 VAC</small>	3	3	3	3		X	X						
F300-9400 <small>Four Price \$3.15 Max 120 VAC</small>	X		X			X							
S300-9410 <small>Single Price \$3.15 Max 120 VAC</small>	X	X	X	X		X	X						
9300L <small>Microtech 110 VPDC</small>					X			X	X	X	X	X	X
9302LF <small>Microtech 24 VPDC 15 Pin Con</small>										X	X	X	X
MARS													
Cashflow										X	X	X	X
TRC6010XV <small>Microtech 24 VPDC 15 Pin Con</small>										X	X	X	X
MC5000 <small>Microtech 117 VPDC \$12.75 Max</small>					X			X	X	X	X	X	X
TRC6000 <small>Microtech 117 VPDC \$12.70 Max</small>					X			X	X	X	X	X	X
TRC6200 <small>120V Single Price \$6.35 Max</small>	X	X	X	X		X	X						
TRC6200H <small>120V Single Price \$6.35 Max</small>	1	4		4			4						
TRC6800 <small>120V Single Price \$10.00 Max</small>	X	X	X	X		X	X						
TRC6800H <small>120V Single Price \$10.00 Max</small>		4		4			4						
MC5802 <small>Single Price 115 VAC</small>	X	X	X	X		X	X						
MC5807 <small>Single Price 115 VAC</small>	X	X	X	X		X	X						
MC5920 <small>Four Price 115 VAC \$6.35 Max</small>	X	2	X	2		X	2						
MC5920H <small>Four Price 115 VAC \$6.35 Max</small>													
MS1600 <small>European 24 VAC 50 Hz</small>									X	X	X	X	X
MS1700 <small>European 24 VAC 50 Hz</small>									X	X	X	X	X
MS1900 <small>European 24 VAC 50 Hz</small>									X	X	X	X	X
NRI <small>National Playators Inc.</small>													
G-26.4400 <small>European 24 VAC 50 Hz</small>									X	X	X	X	X
Askoy													
AN-200										X			X

1= Use with 408-6027 Kit 2= Remove R35 from MC5920 AH when using CBA - 2 B.A. (Also Needs 425-1856 harness)
 3= Needs four price kit 4= B.A. Compatible

550 Features

MESSAGE CENTER

The 550's message center has a 20 character vacuum display that can scroll up to 250 characters, or can be programmed to display a custom message or the time and date.

EASYKEY™ MENU SYSTEM

The 550 is easily programmed using the patented Easykey™ menu system. The Easykey™ menu system divides all of the programmable features into logical menus, which can be accessed using four keys:

<UP> <DOWN>
<SET> <NEXT>

REAL TIME CLOCK

The real time clock keeps track of start and stop times for options and records fault times.

CONVEYOR LOCKOUT

Up to 9 shelves can be reserved until a specified time.

RANDOM FREE VEND

The customer can win a free product. Variable odds (1:50 to 1:3000).

DISCOUNTS

In conjunction with the smart shopper feature, three predetermined discount schedules can be programmed into the machine and enabled at the operator's discretion.

PROGRAMMABLE COIN LOADING

Coins can be loaded through the top or side of the coin mech.

SHELVES

The easily removable shelves can be configured to hold between one and six selections. The configuration can be changed quickly without tools.

CONVEYOR

The shelf conveyor holds sixteen shelves. It can be rotated up or down by the customer.

SLIDE-OUT SERVICE PANEL

The slide-out service panel allows the service person to access all of the 550's control devices without opening the main door.

MIS (MANAGEMENT INFORMATION SYSTEM)

Keeps track of:

SALES BY SHELF
SALES BY PRODUCT CODES
NUMBER OF FREE VENDS
VALUE OF FREE VENDS
NUMBER OF RANDOM FREE VENDS
VALUE OF RANDOM FREE VENDS
NUMBER OF DISCOUNT #1 SALES
VALUE OF DISCOUNT #1 SALES
NUMBER OF DISCOUNT #2 SALES
VALUE OF DISCOUNT #2 SALES
NUMBER OF DISCOUNT #3 SALES
VALUE OF DISCOUNT #3 SALES
NUMBER OF SCHEDULE #1 VENDS
NUMBER OF SCHEDULE #2 VENDS
NUMBER OF SCHEDULE #3 VENDS

The 550 also provides accurate inventory of money in the Cash Box, Coin Mechanism and the Bill Stacker. Sales are recorded as resettable and non-resettable entries.

MULTIVIEW

The conveyor is rotated 3 sections, every 3 minutes at programmable start and stop times.

COIN MECHANISM

The 550 can use either 110 VPDC (12 or 15 pin) or 24 VPDC (15 pin) Coin mechanisms

NOTE: See Coin Mech Chart page iv.

OTHER FEATURES

- Credit Card Reader Capability
- Hard Copy Printout Capability
- Enhanced Blind Operator Feature

SECTION 1

INSTALLATION



INTRODUCTION

This section contains instructions for unpacking the 550 General Merchandiser and installing it on location. Installation is quick and easily accomplished.

Unpacking Instructions

The vendor is shipped in one carton with all major assemblies in place, ready for installation. The shipping carton should be opened carefully to prevent the merchandiser from being scratched or damaged. Inspect the exterior and interior of the cabinet for evidence of damage. In case of damage, please notify the delivering carrier at once to examine the vendor regardless of the external condition of the carton. Under U.S. regulations, damage claims must be collected from the consignee. Do not return shipping-damaged merchandise until after your claim has been established. Once your claim is established, damaged merchandise may then be returned to your Rowe distributor for repair. The invoice for repair charges may then be collected from the carrier. Do not destroy packing material or boxes until the carrier's agent has examined them.

CAUTION !

Pushing or sliding the merchandiser (by hand) on the floor can result in considerable damage to the machine and / or personal injury. Always use appropriate material handling equipment and adequate protective padding to protect the merchandiser.

Set-Up Instructions

1. Place the unit in a well ventilated location with a minimum of SIX INCHES between the unit and the back wall.
2. Remove all tape and packing material from the cabinet.
3. The unit must be leveled. Use the illustration below as a guide.

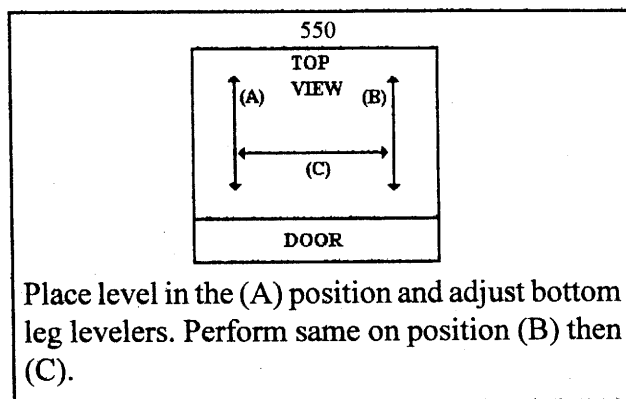

CAUTION !

If unit is not leveled correctly the evaporator may freeze up, causing unit shutdown.

4. Ensure that all circuit breakers are firmly in place and that the fluorescent lamps are secure in their sockets.
5. Ensure that the main power switch is in the OFF position.
6. Plug the line cord into a dedicated 120 VAC 60 Hz. positively grounded (3-prong) receptacle capable of delivering 20 amps.
7. Install a recommended Coin Mech (See Specification Sheet page ii).

- a) Check coin chute alignment.
- b) Check coin return lever operation.
- c) Adjust if necessary.
- 8. Ensure that all electrical connections are seated properly, especially at the circuit boards.
- 9. Ensure that dip switch #2 on the UCB is set to **ON** if you have a **REFRIGERATED** machine and **OFF** if you have an **AMBIENT** machine.
- 9. Turn the main power switch ON.
- 10. The message center should display:
 - a. "SELF TEST OK VER #.##"
 - (VER = latest version of message center display)
 - {Then}
 - b. "ROWE 550 - REV X"
 - (REV = latest revision EPROM on UCB)
 - {Then}
 - c. "AMBIENT / REFRIGERATED MACHINE"

NOTE: Ensure that item 'C' above is the type of machine you have.

Dip Switch #2 on the UCB is used to set this option.

ON = Refrigerated
OFF = Ambient

{Then}

- d. "SERVICE MENU" or "XX ERROR MESSAGES"
- 11. Check that all fluorescent lamps are illuminated.
- 12. Ensure that the following LEDs on the Universal Control Board are illuminated:
 - +5 VDC** (Logic Voltage)
 - VFD** (Vacuum Fluorescent Display voltage)
 - VSRC** (Device Source voltage)
 - TEST** Blinking (Control Board operating heartbeat)
- 13. Perform a full initialization to program the machine to factory default settings.
 - A. In the Service Mode depress the <NEXT> key until the message center displays "DEFAULT MENU"

- B. Depress the <SET> key; "MACHINE INIT - NONE" displays.
- C. Depress the <UP> key until; "MACHINE INIT - FULL" displays.
- D. Depress the <SET> key; "TURN UNTIL ZERO POS" or "SERVICE MENU" displays.
- E. If "TURN UNTIL ZERO POS" is displayed, rotate the shelves with the outside transport switch until "SERVICE MENU" displays.

NOTE: Main door must be closed or "MAIN DOOR IS OPEN" Message will be generated.

- 14. If you have a refrigerated unit, ensure that the temperature control is set at '4'.

Coin Mech Loading

- 15. This unit must be set up for total cash accountability to operate correctly. You may use one of these two methods to load the coin mechanism.
 - A. In the Service Mode all coin denominations may be loaded through the top flight deck of the coin mech.
 - B. Programming Method: You must keep count and load all the coin denominations through the side loading tubes. The inserted amounts can be keyed into the program. (See page 3 - 12 of the MIS MENU Section, - Set Coin Tubes).
- 16. Configure shelves. Refer to page 2-4.
- 17. Set prices. Refer to page 3-10, PRICE MENU.
- 18. Load product.

NOTE: If you have a refrigerated machine, allow the temperature to stabilize between 34° - 39° F before loading temperature sensitive product.

PRE-OPERATION CHECK

1. Perform the Basic Program Set-up routine located in the Service Mode Operation section, page 3 - 4.
2. Close all machine doors. "INSERT MONEY" or other vending mode messages should display if all parameters were set correctly and no errors exist.
3. Rotate the conveyor one full revolution using the <UP> arrow button.
4. Rotate the conveyor one full revolution using the <DOWN> arrow button.
5. Insert Coins (5¢, 10¢, 25¢) and make a vend.
6. Check and verify the coin return amount.
7. (If equipped with Bill Acceptor) Insert bill(s) and make a vend.
8. Check and verify the coin return amount.
9. Test vend every vend door, rotating the conveyor one shelf between vends.
10. Close and latch the main door to reset the electronic count-down timer. The vendor now has 30 minutes to reduce the interior cabinet temperature to 45° F (7.2° C). The vending circuit will be interrupted by the controller, if the temperature requirement is not satisfied. **(Refrigerated units only.)**

NOTE: (Refrigerated units only.)

On initial start up in high ambient temperatures it is normal to experience a shut down after the first 30 minutes. Simply open the service door and clear the "Health Time Expired" error. Open and then reshut the main door (This resets the 30 minute health timer). No further shutdown should occur.

SECTION 2

DESCRIPTION

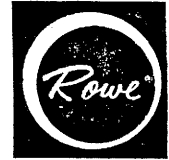

Introduction

The 550 General Merchandiser can be used to vend refrigerated or non-refrigerated products. The unique vertical shelf movement and versatile shelf configuration make this vendor ideal for many locations.

Product is vended from 16 shelves which rotate vertically inside the vendor. The shelves can be set up in a variety of configurations, with a maximum shelf capacity of 6 items.

The shelves are rotated by pressing the **up** or **down** button located on the display panel. When the appropriate shelf reaches the delivery door, the button is released and the conveyor stops rotating.

Selections are made by pressing one of the six selection buttons located below the delivery door. Once a selection choice has been made, the inner delivery door opens and the customer can open the outer delivery door to remove his purchase. A vend can be aborted at any time, prior to opening the vend door, by pressing the coin return button. As a safety precaution, the inner delivery door will not close while the outer delivery door is open.

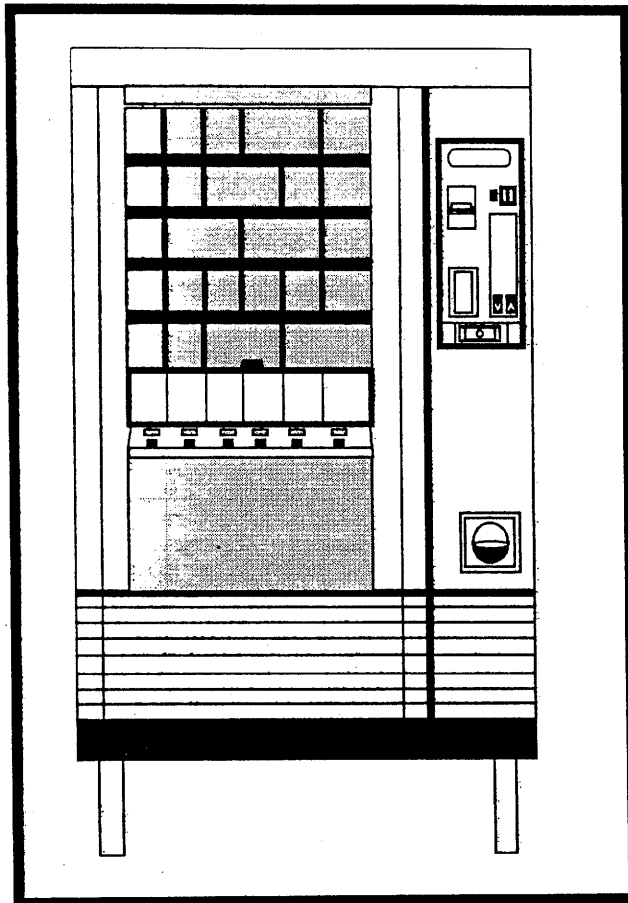

Figure 2-1
Exterior of the
550 General
Merchandiser

Management Information System (MIS)

The 550 provides detailed MIS information in a printed or displayed format. MIS includes vital diagnostic information such as error codes, and

sales information such as total cash collected and product code counts.

Delivery Doors

The 550 incorporates a dual delivery door system. The outer delivery door spans the width of the delivery section. Each of the six inner delivery doors, called baffles, accesses one 4" shelf section. When an item is selected for purchase the outer delivery door is unlocked. At the same time, the baffle corresponding to the purchased item is opened. All of the other baffles remain closed. In the case of a purchase from a compartment that has been expanded to include more than one 4" shelf section, each of the baffles for that selection will open. See the illustrations below for a working explanation.

The baffles will remain open for three minutes or until the conveyor is advanced, another selection is made or additional credit is introduced. This prevents the possibility of the customer losing his purchase if the outer delivery door is inadvertently shut. The outer delivery door remains unlocked as long as the baffles are open.

When the shelves are rotated, or another selection is initiated, the baffles are closed and the baffle latches are reset by a sliding lock-bar.

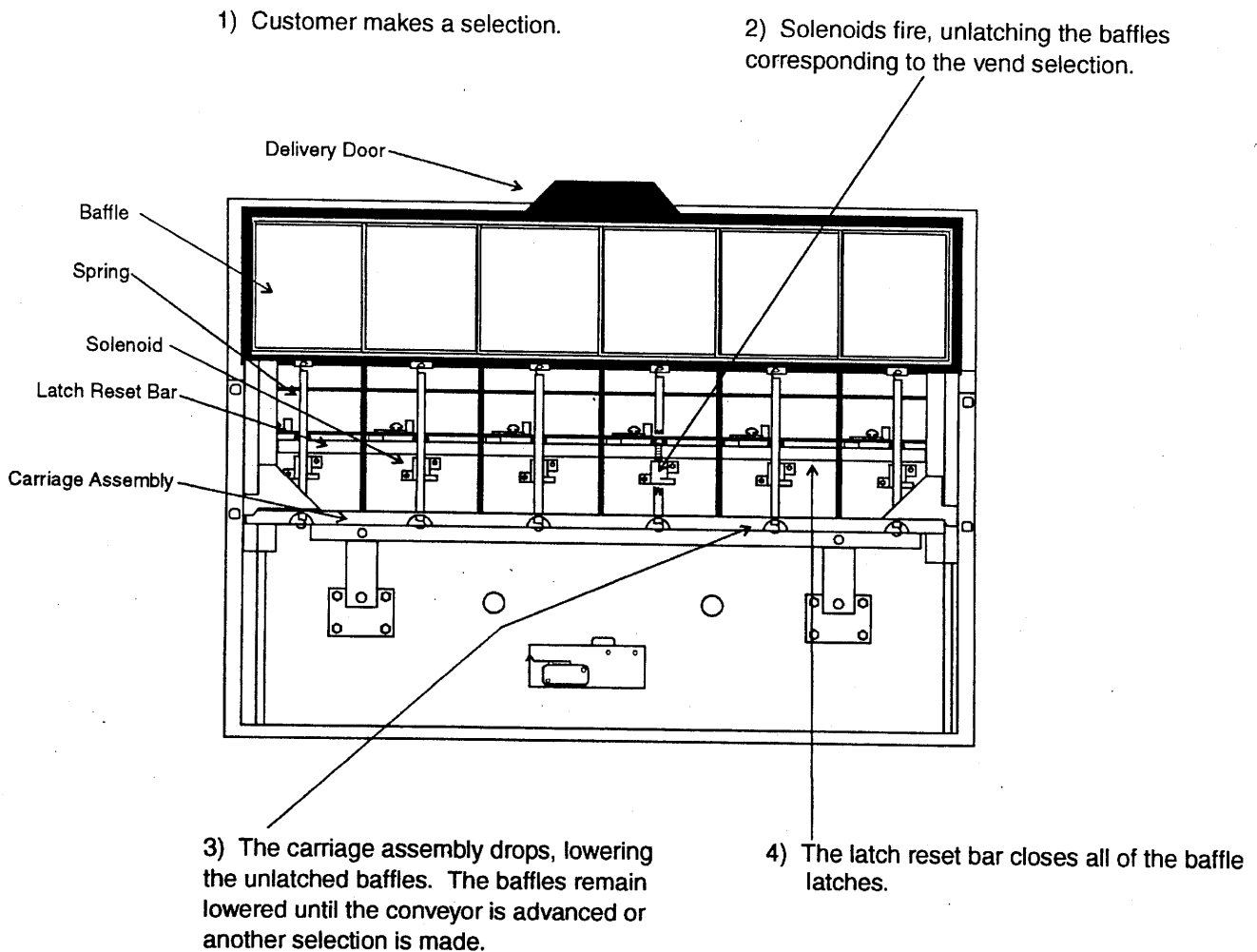

Slide-Out Panel

The slide-out service panel, located to the left of the main door, houses all of the machine's control systems. Located on the slide-out panel are the universal control board, the power supply, the slide-out keypad used to access the UCB, the coin mech, the bill acceptor, and a junction box containing a convenience plug, a printer port and the coin mech socket.

When the service panel is opened, the machine is automatically placed in the service mode. In the service mode the operator can access all of the programming menus using the <UP>, <DOWN>, <SET> and <NEXT> keys located on the slide-out keypad.

The slide-out panel allows the operator to have access to all of the machine's control systems without opening the main door.

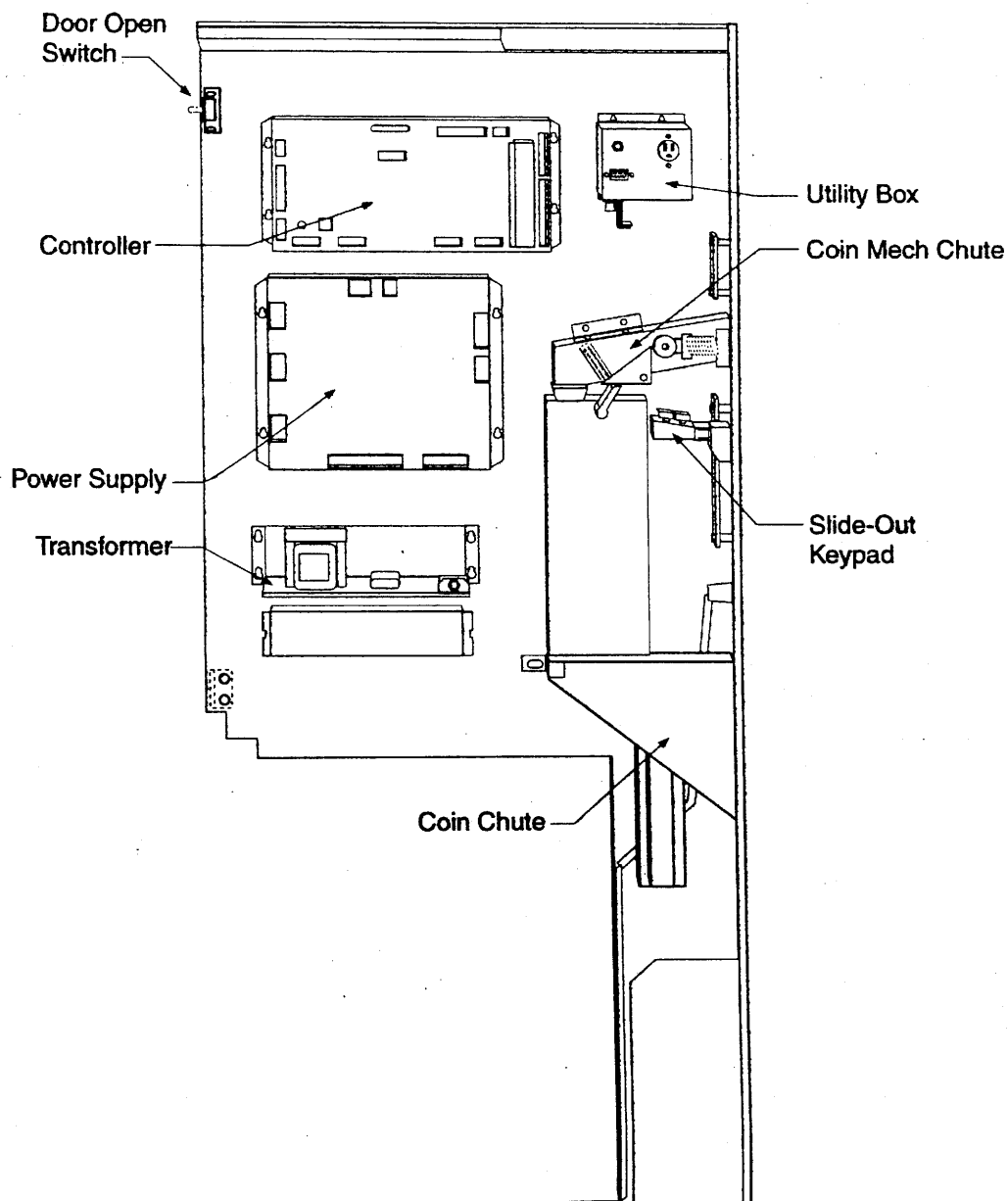

Universal Control Board

The Rowe Universal Control Board is the "brain" of the 550 General Merchandiser. The UCB controls all of the 550's peripheral devices, such as the coin mech, bill acceptor and refrigeration unit, as well as all of the machines vending functions and special features. The Universal Control Board also collects and stores vital machine information, such as error messages and MIS data. The controller maintains coin counts and coin tube levels for the coin mech. The refrigeration system is completely controlled by the UCB. The UCB monitors the temperature of the food compartment, and applies the compressor algorithm to maintain the appropriate temperature parameters.

E-PROM

The UCB runs a computer program stored on the E-PROM. The E-PROM is removable and can be updated as new software revisions become available. A label on the top of the E-PROM indicates the revision level of the software loaded on it. Service to the controller, including the removal of the E-PROM, should be performed by qualified personnel only.

The UCB is located on the slide-out service panel assembly and is easily accessed without opening the main door. UCB functions are accessed through a slide-out keypad located behind the display board assembly on the interior of the sliding door. Refer to Section 3 for detailed programming instructions.

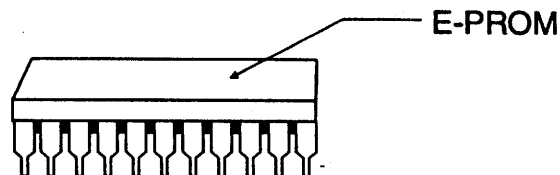
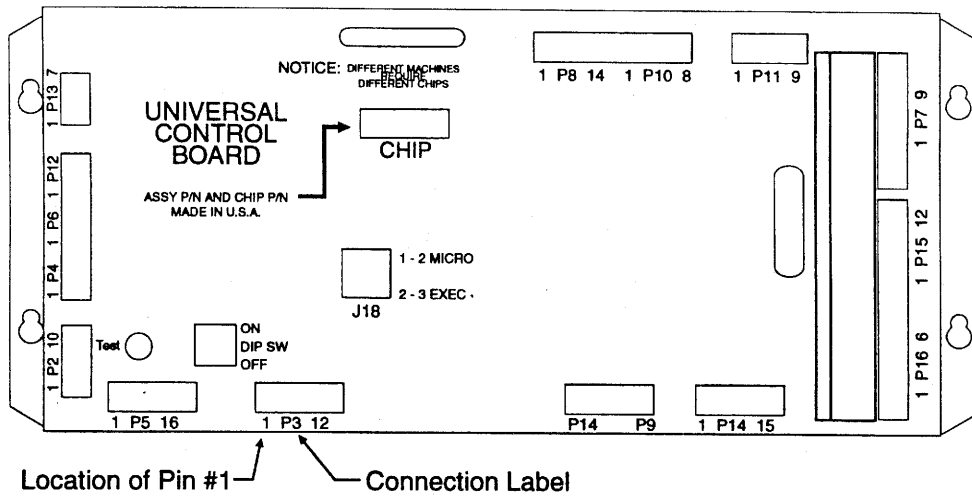

Shelves

The 550 vends product from a series of sixteen 24" horizontal shelves which can be rotated up or down by the customer. Each shelf is divided into six 4" sections. The shelves can be easily configured, by removing or adding shelf dividers, to house any combination of 4" compartments. A divider lockbar spans the top of the shelf, and attaches to both sides. The lockbar holds the dividers firmly in position, deterring theft of product from unpurchased compartments.

Zero Position

One of the shelves has a magnet attached to the back of it, used to indicate zero position. The zero position is as a point of reference for the controller and is used to determine the programmed prices and compartment configurations. **If the zero position shelf is moved to a new location, relative to the other shelves, the prices and shelf configurations must be reprogrammed.** If the machine goes out of service, the shelves must be rotated until the zero position is located before the vendor can be placed back into service.

Loading Shelves

Product must be loaded so that it does not extend beyond the top or front edges of the shelf. Product will shift as the conveyor rotates; ensure that product is loaded so that it will not shift beyond the boundaries of the shelf. If the product extends beyond the boundaries of the shelf, the product will cause the conveyor to bind up, resulting in damage to the shelves, shelf carriers, drive chain, and loss of product.

Load heavier products on the left side of the shelves. The components on the left side of the shelves are designed to handle the greater stress produced by heavier products.

Load all shelves with approximately the same weight load.

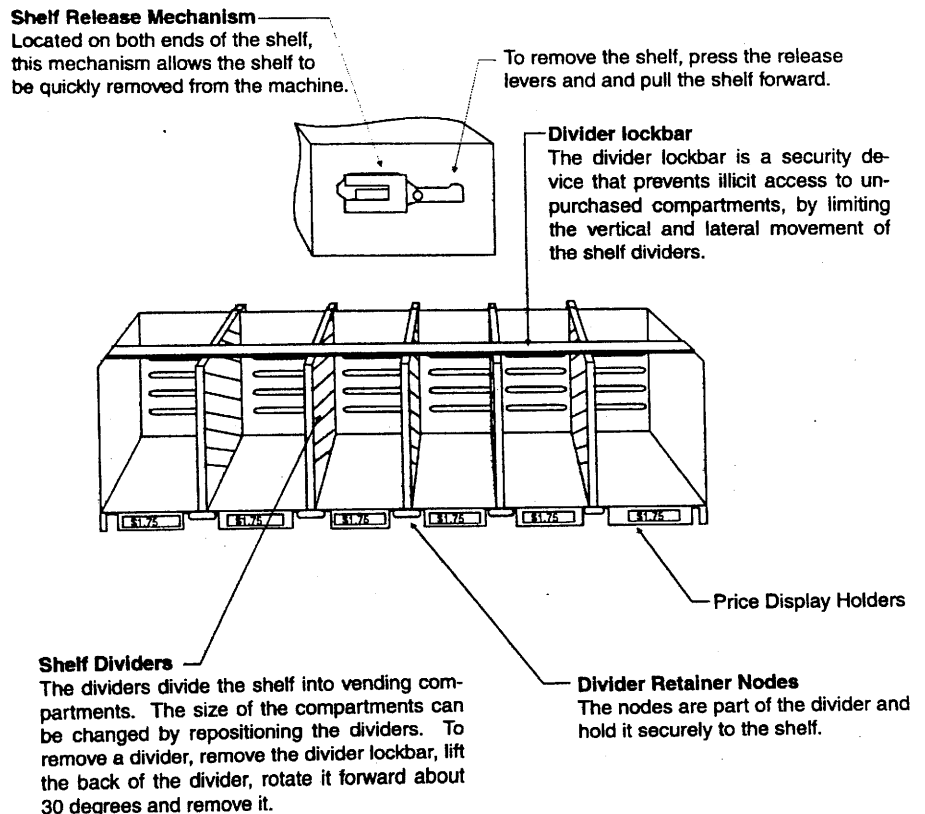

Main Power Switch Assembly

Located at the lower left side of the cabinet interior, the main power switch assembly houses the main power switch, the refrigeration power circuit breaker, the vend power circuit breaker and the refrigeration interlock switch, which shuts the refrigeration unit down when the main door is open or ajar.

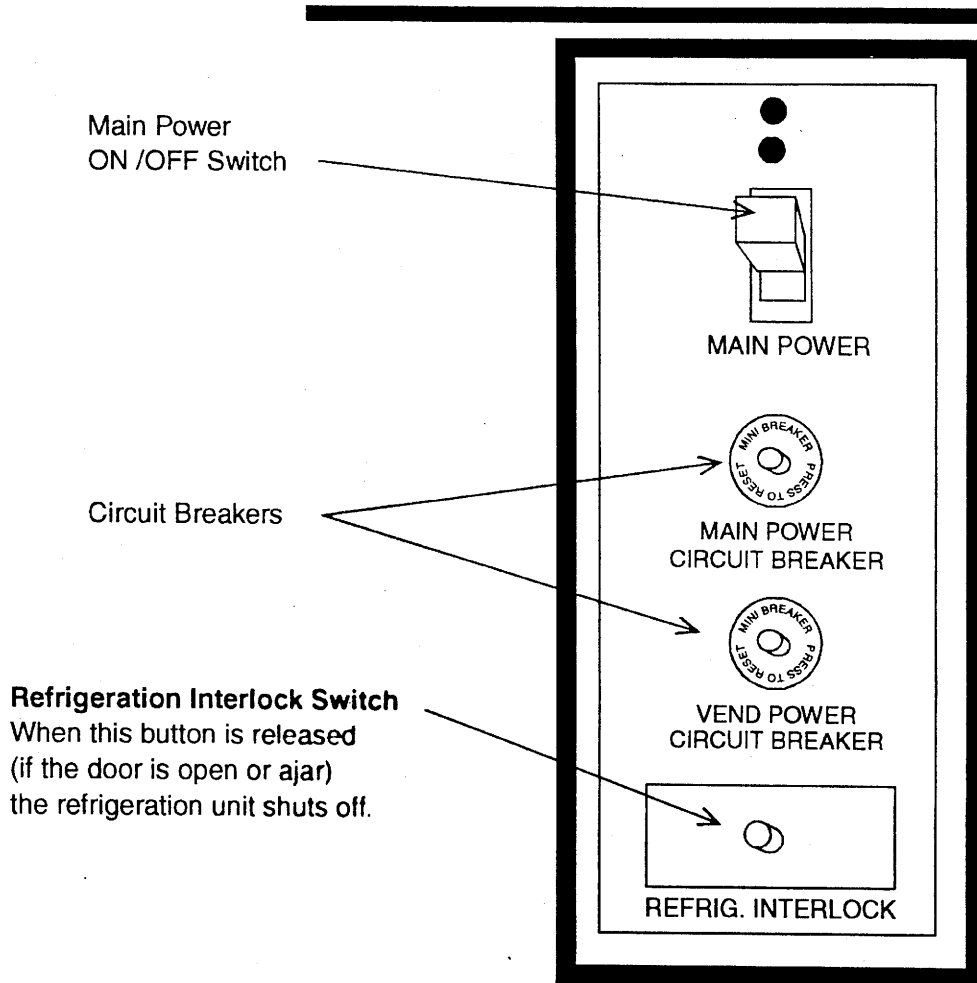

Price Display and Selection Panel

There are six price displays located below each of the product compartments. A selection button is located below each price display. As the shelves rotate in the machine, the prices change as the trays enter the vend position. If the selection occupies an expanded cell, the price will be displayed in the left-most display cell and the other price displays will display dashes. The customer can press any of the selection buttons under an item to make the purchase. The selection buttons also operate as 'hot keys' used to access diagnostic information without opening the main door or accessing the service mode. See page 3-7 for a list of 'hot keys'.

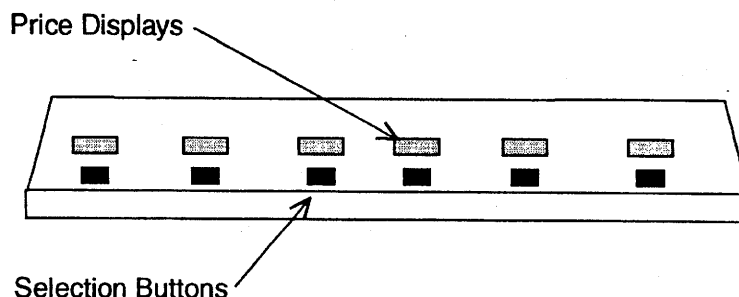

Drive Mechanism

The trays are mounted on individual carrier assemblies, which travel on a fixed guide track. The carriers are connected to drive chains, which are turned by drive sprockets. The drive sprockets are powered by a 90V motor located in the service compartment. The carrier assemblies on the left side of the cabinet use alignment gears to keep the shelves horizontal.

Alignment Gears
Keep the shelves horizontal.

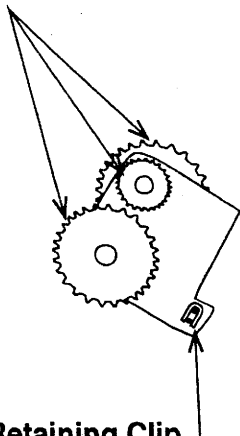

Retaining Clip

This clip connects the carrier assembly to the drive chain. It must be removed before the carrier assembly is removed.

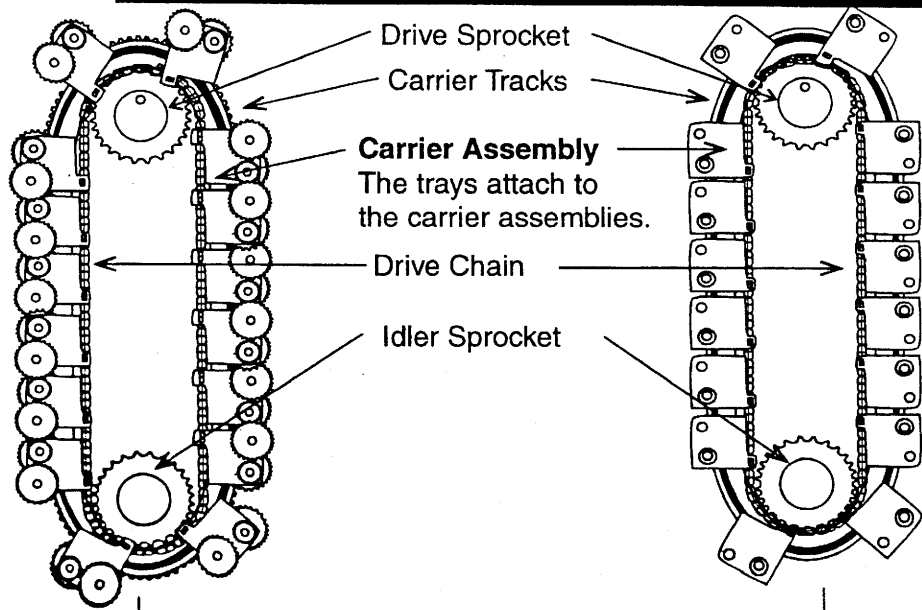

Drive Shaft

Drive Motor

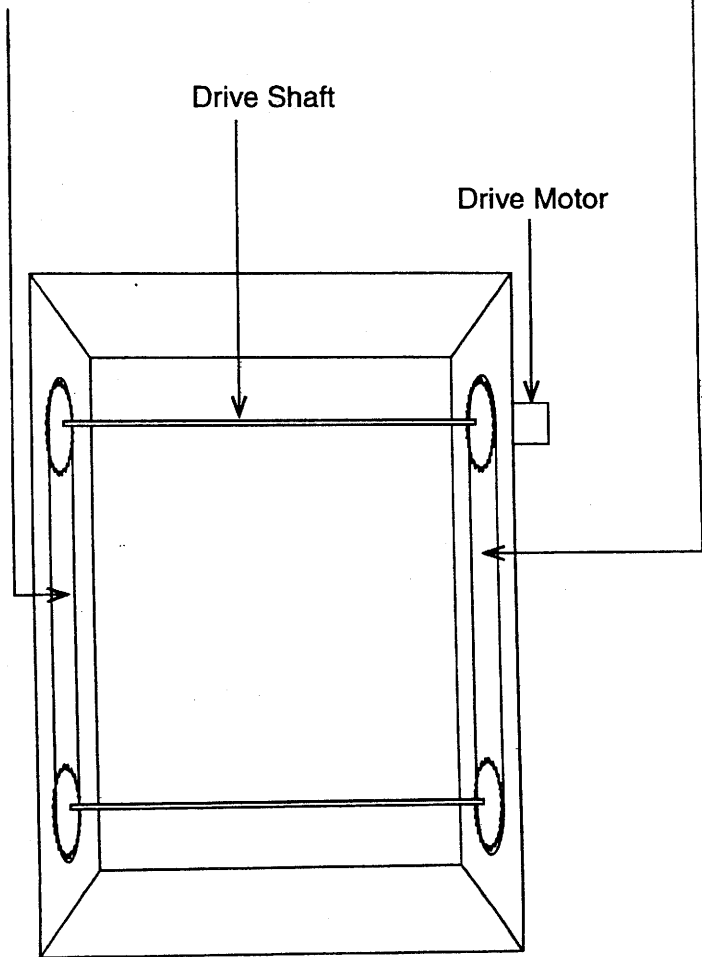

Caution

Do NOT advance the shelf assemblies without ALL of the trays installed. Doing so will cause the carrier assemblies to become misaligned and may cause damage to the drive mechanism.

Refrigeration System

The self contained refrigeration unit is designed to slide in and out of the unit as a complete assembly. A normal 3 pin AC power cord supplies 12 amps. to the compressor, evaporator blower and the condenser fan. During the normal operating cycle, the evaporator blower runs continuously while power is applied, regardless of the temperature inside of the refrigerated compartment. The evaporator blower will run during the defrost cycle. The condenser fan runs only when the compressor is running. The compressor and condenser fan are both controlled by a relay, P/N 938-8001. The defrost heaters are also controlled by a relay, P/N 938-8001. Both relays are located below the manual backup temperature control in the refrigeration control compartment. During normal operation, the temperature of the food compartment is regulated by the universal control board. The temperature will be maintained at 34°-39° F, according to the compressor algorithm described below.

When the main door is opened, the compressor fan, condenser fan and evaporator blower are turned OFF. When the main door is closed, there is a one minute delay before power is applied to the compressor and the condenser fan. The evaporator blower will start immediately after the door is closed. If power is interrupted for any reason, the delay described above will occur before the

compressor and condenser are started. This delay helps prolong the life of the compressor by eliminating rapid on/off cycling.

Note:

The compressor control cycling runs independently of the health control processing. If the machine goes out of service, the compressor will continue to operate.

Compressor Algorithm

The compressor will turn ON two minutes after closing the main door or initiating the start-up sequence. It will remain ON until the temperature inside the food compartment is below 34° F. Once the temperature inside the food compartment falls below 34° F, the compressor will shut off, and remain off, until the temperature inside the food compartment reaches 39° F.

Defrost Routine

Every two hours the refrigeration unit enters a defrost routine. The compressor and condenser fan will shut off and the heaters will come on. The heaters will remain on for 5 minutes, or until the compartment temperature reaches 41° F. Once the temperature reaches 41° F or the 5 minute period expires, the compressor and condenser fans will turn on. The evaporator blower runs during the defrost cycle.

Caution! This unit must be serviced only by certified refrigeration technicians. Unauthorized service or repair will void the warranty on this unit.

Caution! This unit contains R-134A refrigerant. This unit is not compatible with any other type of refrigerant. Use of any other type of refrigerant in this unit will damage the refrigeration unit, and may result in personal injury. Use of any refrigerant other than R-134A will void the unit's warranty.

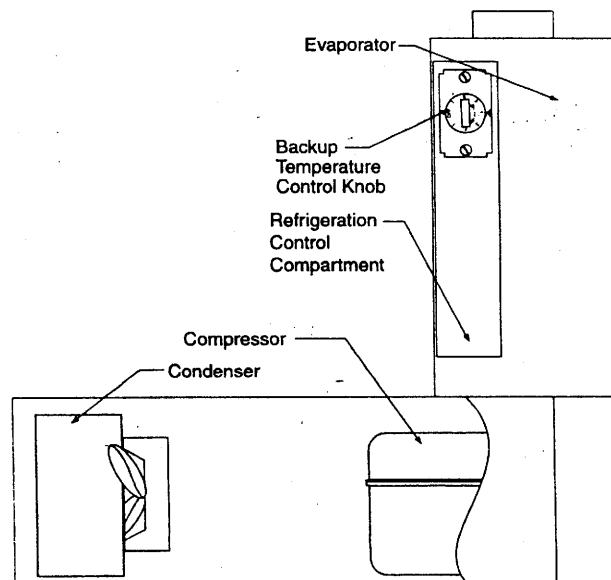

Backup Temperature Control

The backup temperature control knob should be set at '4'. Under normal circumstances, the temperature of the vendor is controlled by the UCB, and is kept within the parameters described above.

Backup Refrigeration Circuit

During normal operation, the backup relay, located in the refrigeration control compartment, is held energized by electronics on the power supply board and controlled by signals from the Universal Control Board. Under certain circumstances, i.e. power failure to the UCB, the backup relay will de-energize. When this happens, the backup temperature control is connected to the refrigeration circuit and the refrigeration unit is kept in operation.

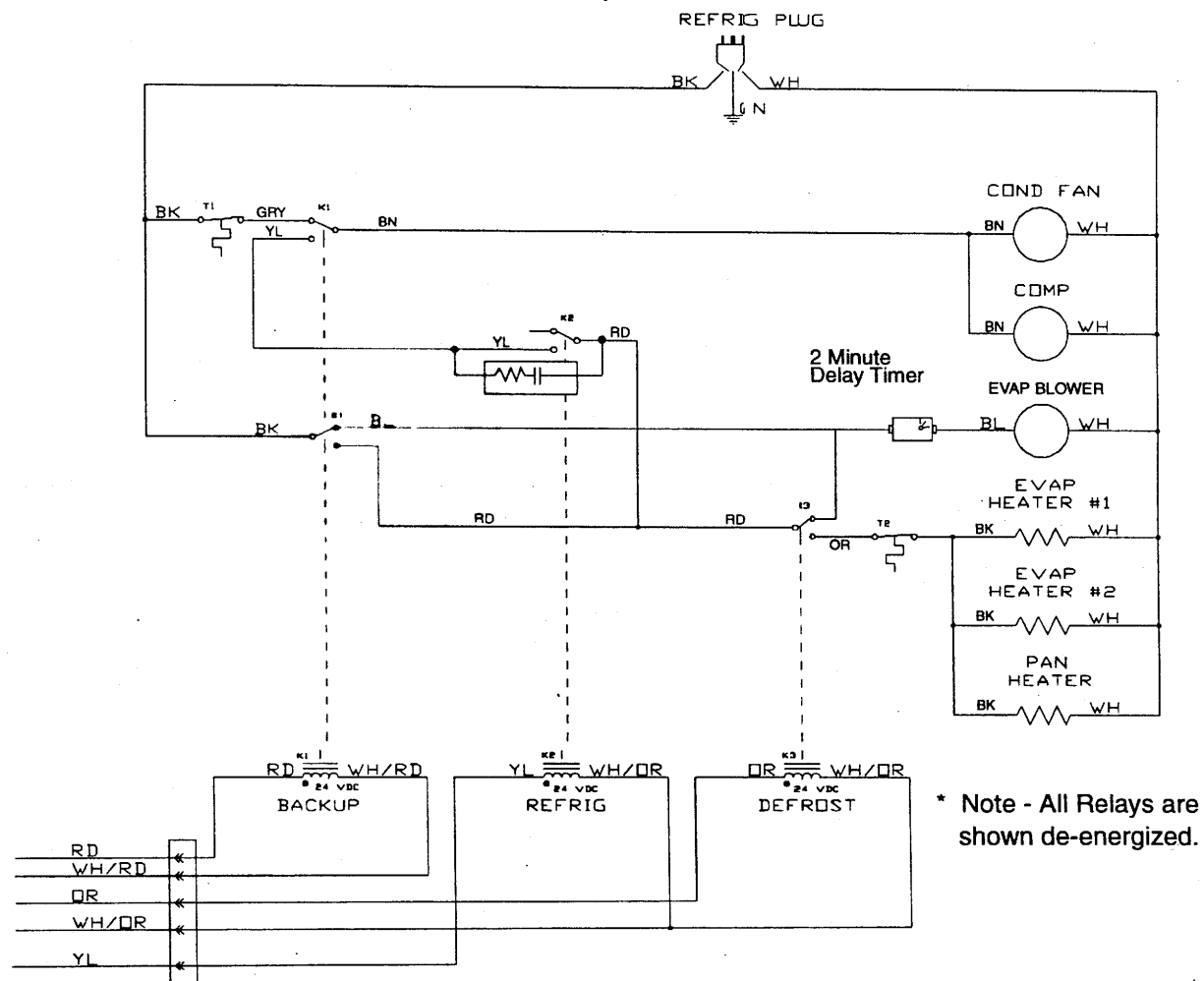

Backup Thermostat

If the temperature control sensor is disconnected, the temperature will read above 80° F, regardless of the temperature inside the cabinet. In this circumstance, the vendor will switch to the backup refrigeration circuit and the backup thermostat. The compressor will cycle ON/OFF according to the compressor algorithm stated earlier. The defrost cycle will not occur when the unit is in the backup mode.

Point of Sale Messages

Messages Prior to Credit

SORRY-OUT OF SERVICE This message will appear whenever there is an error condition logged by the software. The display lamps will be OFF when one or more error conditions exist.

INSERT MONEY This message appears when a Bill Validator is configured and there is sufficient change in the Coin Mechanism.

EXACT CHANGE PLEASE This message appears whenever there is insufficient change in the Coin Mechanism. Users can buy with an over credit and the machine will try to make the correct change.

COINS ONLY PLEASE This message appears only when a Bill Validator is not configured and there is sufficient change.

MAKE FREE SELECTION Machine is in Free Vend. No money is required.

HEALTH CONTROL ON 30 Minute Health Delay expired. Depress <BLANK> Key and then the <H> Key.

ONE MOMENT PLEASE Machine is locating zero position.

11.59PM SUN 12/31/91 Depress <BLANK> Key and then <D> Key. Time - Day of Week - Date.

TEMPERATURE 36 F Depress the <BLANK> Key and then <F> Key. Displays current temperature of Vend Compartment.

HEALTH DELAY 30 MINS Time remaining during 30 Minute Health Delay, Depress the <BLANK> Key and then the <H> Key.

MAIN DOOR IS OPEN Attempt is made to advance the conveyor with the keypad when the main door is open.

Credit Messages

CREDIT - \$ 1.25 Purchaser's current credit, validated by the Coin Mech and/or Bill Validator.

Selection Messages

INSUFFICIENT CREDIT Not enough credit to purchase item.

MUST MAKE SELECTION <Coin Return> depressed when vendor has Forced Vend Option in use.

YOU ARE A WINNER Random Free Vend Option is on. Customer receives Free Vend.

CAN'T MAKE CHANGE Prohibit Overbuy Option is on, correct change unavailable for vend selected. Forced Vend must be OFF.

ITEM PREVIOUSLY SOLD This message appears when a vend door with a previously purchased compartment is attempted to be opened.

RESERVED SECTION Conveyor delay is in use. Cannot vend from that selection.

OPEN On Display when a vend door is open.

Vend Completed

THANK YOU Transaction has been completed successfully.

SOLD On Display when an item has been sold.

POINT OF SALES MESSAGES

ENGLISH

THANK YOU
 CREDIT - \$ 1.25
 COINS ONLY PLEASE
 INSERT MONEY
 OPEN
 EXACT CHANGE PLEASE
 KEY D
 SHELF J NOW READY
 MAKE FREE SELECTION
 HEALTH CONTROL ON
 ITEM PREVIOUSLY SOLD
 INSUFFICIENT CREDIT
 MUST MAKE SELECTION
 SORRY-OUT OF SERVICE
 RESERVED SECTION
 ITEM IS NOT AT DOOR
 YOU ARE A WINNER
 CAN'T MAKE CHANGE
 ONE MOMENT PLEASE
 11.59PM SUN 12/31/91
 11.59PM MON 12/31/91
 11.59PM TUE 12/31/91
 11.59PM WED 12/31/91
 11.59PM THU 12/31/91
 11.59PM FRI 12/31/91
 11.59PM SAT 12/31/91
 TEMPERATURE 36 F
 TEMPERATURE 7 C
 HEALTH DELAY 30 MINS
 OPEN
 SOLD
 MACHINE I.D. _ _ _ _

FRENCH

MERCI
 CREDIT - \$ 1.25
 PIECES SEULEMENT SVP
 INTRODUIRE PIECES
 PORTE A OUVERTE
 MONTANT EXACT SVP
 APPUYER LA TOUCHE D
 PLATEAU J PRET
 SELECTION GRATUITE
 CONTROLE EN COURS
 ARTICLE VENDU
 MONNAIE INSUFFISANTE
 DOIT FAIRE UN CHOIX
 HORS SERVICE
 SECTION RESERVE
 ARTICLE NON-ALIGNE
 VOUS AVEZ GAGNE
 CAN'T MAKE CHANGE
 UN MOMENT SVP
 11.59PM DIM 12/31/91
 11.59PM LUN 12/31/91
 11.59PM MAR 12/31/91
 11.59PM MER 12/31/91
 11.59PM JEU 12/31/91
 11.59PM VEN 12/31/91
 11.59PM SAM 12/31/91
 TEMPERATURE 36 F
 TEMPERATURE 7 C
 DELAI DE TEMP 30 MIN
 OPEN
 SOLD
 MACHINE I.D. _ _ _ _

SPANISH

GRACIAS
 CREDITO - \$ 1.25
 SOLO MONEDAS
 INTRODUCIR MONEDAS
 PUERTA A ABIERTA
 CAMBIO EXACTOPRESS SELECTOR
 SELECCIONE TECLA D
 REPISA J PREPARADA
 SELECCIONE
 REVISANDO PRODUCTO
 ARTICULOS AGOTADOS
 CREDITO INSUFICIENTE
 SELECCIONE OPCION
 FUERA DE SERVICIO
 PRODUCTO ELEGIDO
 ARTICULO AGOTADO
 HAS GANADO
 CAN'T MAKE CHANGE
 UN MOMENTO POR FAVOR
 11.59PM DOM 12/31/91
 11.59PM LUN 12/31/91
 11.59PM MAR 12/31/91
 11.59PM MIE 12/31/91
 11.59PM JUE 12/31/91
 11.59PM VIE 12/31/91
 11.59PM SAB 12/31/91
 TEMPERATURA 36 F
 TEMPERATURA 7 C
 REVISION 30 MINS
 OPEN
 SOLD
 MACHINE I.D. _ _ _ _

TABLE 2 - 1 POINT OF SALE MESSAGE

Health Control

The 550, when configured as a refrigerated unit, employs a health control feature to monitor the interior cabinet temperature.

After opening and closing the main door, the refrigeration unit has 30 minutes to bring the temperature below 45° F. If the temperature does not fall below 45° F, the machine will go out of service. A "HEALTH TIME EXPIRED" message will be recorded by the universal control board.

It is normal for the machine to experience a health code violation during the initial start-up if the machine is placed at a location with high humidity and high ambient temperature. If this occurs, simply open and shut the main door to reset the

health timer. Clear the error message. It should not take the merchandiser more than 2 cycles to reach proper operating temperature.

During normal operation, the health control feature monitors the temperature of the cabinet. If the temperature rises above 45° F for a one minute period the machine will go out of service. Troubleshoot the merchandiser using the troubleshooting charts in Section 4.

Service Mode Operation Table of Contents

Error Messages	3-3
Blind Operator Feature	3-3
Basic Program Set-up	3-4
Security Code	3-4
Exact Change Mode	3-5
Quick Reference Guide	3-5
MIS Defaults	3-6
Miscellaneous Information	3-7
Hot Keys	3-7
Service Mode Menu Flowchart	3-8
Mini Menu System	3-9
Price Menu	3-10
MIS Menu	3-12
Options Menu	3-19
Clock Menu	3-25
Conveyor Menu	3-26
Autoprice Menu	3-27
Discount Menu	3-29
Diagnostic Menu	3-31
Default Menu	3-33





SECTION 3

PROGRAM OPERATION





INTRODUCTION

The Universal Control Board uses a menu driven interface to configure the vendor, choose from available options, access MIS information, and troubleshoot this vendor. Opening the slide-out service door will automatically bring you into the "SERVICE MODE MENU". There are nine menus through which the 550 General Merchandiser is programmed. The service keypad has ten service keys which are used to access the Easy Key™ Menu System and other machine features.

The , , , and  function keys are all you need to use the EasyKey™ Menu System. Below is an explanation of how to move through the menus using the function keys.

 Move from one menu to the next. This can be done at any time.

 Enable a setting within a menu.



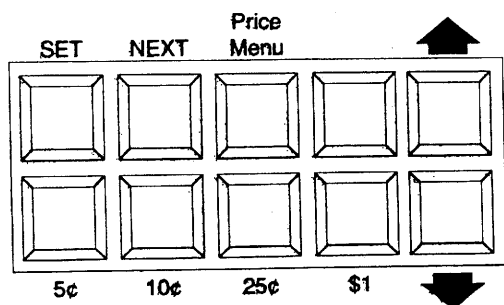

 or  Change the value of a setting.



The <5¢ >, <10¢ >, and <25¢ > keys are used to dispense coins from the coin mech. The <\$1 > key will be used for the dollar coin when it becomes available.



Error Messages

When the service door is opened, the display will show "**** SERVICE MENU ****". If there were any error conditions recorded since the last time the door was opened, the display will show "XX ERROR MESSAGES". XX represents the number of messages recorded. The error messages in the error queue will be displayed chronologically beginning with the most recent error. Duplicate messages will appear only once.

Press the  key and the display will list the error(s) that have been recorded. Continue pressing the  key to see all the errors. After all error messages have been shown, the display will show "CLEAR ERRORS - NO". Use the  or  key to select "YES" or "NO". Press the  key.

If you select "NO", the errors will still be logged the next time the door is opened.

If you select "YES", all the error messages will be cleared. This does not correct any problems. It only clears the messages.

If you do not want to see each individual error message press the  key to display "CLEAR ERRORS - NO". Use the  or  keys to select "YES" or "NO".

Blind Operator Feature

When dip switch #1 is set to ON, the Price Menu key gives the operator direct access to the Set Prices option of the Price Menu. The reset solenoid will be activated at each programming step in order to provide aural feedback to the operator. The 550 uses different tones for various operations. Familiarize yourself with these tones by experimenting

BASIC PROGRAM SET-UP

This section covers a quick Set-up for customers not interested in utilizing special features.

Open the Service Door to display and enter the "SERVICE MODE".

If "ERROR MESSAGE" displays, refer to 4-6 & 4-7 to troubleshoot the error.

1. COIN MECH

Load all coin denominations through the coin mech's top flight deck.

NOTE: If coins are loaded through the side tubes, there is no accountability unless the amount inserted is programmed in the MIS Menu.

2. SET PRICE

Perform the following:

Depress Key	Displays
A. NEXT	"PRICE MENU"
B. SET	"PRICE SCHED - 1 ACTIVE"
C. SET	"SET PRICE 1 - \$ X.XX"
D. UP or DOWN	"SET PRICE 1 - \$ X.50"





(Use arrow keys to adjust the price up or down).

Press the first selection on the left side of the horizontal display one time. It will start blinking. If the selection is to contain only the first compartment, press the selection button again. If the selection is to contain more than one compartment, press the selection button

that will be the far right boundary of the selection. The display to the immediate right will start blinking, repeat the above steps for the rest of the shelf.

3. ENABLE BILL ACCEPTOR

If unit is equipped with Bill Acceptor, perform the following:

- A. Depress the  key until "OPTION MENU" displays.
- B. Depress the  key until "BILL ACCEPTOR OFF" displays.
- C. Depress  or  key to toggle Bill Acceptor enable to OFF or ON.
- D. Depress the  key to exit Option Menu.
- E. Repeat steps B, C & D for \$1 Accept / Reject, \$2 Accept / Reject and \$5 Accept / Reject.

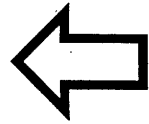

When setting prices, always start at the left and set all of the selections for the entire shelf.

Blind Operator Feature (Continued)



with the vendor. To set prices in the blind operator mode:



- 1) Press the Price Menu key. The vendor will enter the Price Menu. The price option is reset to \$0.00. A loud click will be made by the reset solenoid to signify that the price has been reset to zero.
- 2) Press the up or down arrow buttons to change the value of the price.
- 3) Press the selection button located on the horizontal display corresponding to the price being set.

NOTE: The key located to the left of the Price Menu will replay the currently displayed price in variant tones.

NOTE: Shelves cannot be configured in the blind operator mode.

Security Code

The security code feature is used to restrict access to specific menus. If the Security Code feature is enabled, the display will show "SECURITY CODE - ****" prior to entering the service mode. Use the  or  keys to display the first character in the security code. When the first character is displayed, press the  key. Continue this procedure for the remaining characters in the security code.

After entering the correct security code and pressing the  key the message center will display, "FULL ACCESS GRANTED". If the security code is unknown the operator may press the  key, which will enable him to have access only to unrestricted menus.

Exact Change Mode

When the 550 is in exact change mode, "EXACT CHANGE ONLY" will be displayed on the message center. The 550 is always in exact change mode unless one of the following conditions is met.

1. Two dimes and a nickel, or 5 nickels are in the tubes, then "COINS ONLY PLEASE" will be displayed on the message center (when B/A is disabled).
2. The bill acceptor is enabled and 3 quarters, 2 dimes and a nickel, or 3 quarters and 5 nickels are in the coin tubes, then "INSERT MONEY" will be displayed on the message center.

QUICK-REFERENCE GUIDE

To set prices:

1. Press the NEXT key on Message Center to reach (PRICE MENU).
2. Press the SET key to reach (PRICE 0.00).
3. Change the price shown by using up or down keys.
4. After selecting the price desired, press the first selection on the left side of the horizontal display one time. It will start blinking. If the selection is to contain only the first compartment, press the selection button again. If the selection is to contain more than one compartment, press the selection button that will be the far right boundary of the selection. The display to the immediate right will start blinking, repeat the above steps for the rest of the shelf.

To payout change from coin mech (manually):

1. Press the coin switch (5¢, 10¢, or 25¢) on the service keypad.

To extract MIS data:

1. Press the NEXT key on the Service Keypad to reach (MIS MENU).
2. Press the SET key to advance through each MIS category.
3. (SALES <N>) is the Non-resettable (cumulative) cash meter.
4. (SALES <R>) is the Resettable cash meter.

To print MIS data:

1. Connect a compatible printer using a proper interface cable. (Rowe P/N 0593-1800)
2. Press the NEXT key on Message Center to reach (MIS MENU).
3. Press the SET key to reach (PRINT MIS DATA -NO).
4. Press the up or down arrow key to select (PRINT MIS DATA -YES).
5. Press the SET key to print the data.

To clear an error (if the lights go out, but prices remain lit):

1. Error descriptions will appear when the service door is opened.
2. Press the SET key each time an error message displays.
3. (CLEAR ERRORS -NO) will appear.
4. Press the up or down arrow key to select (CLEAR ERRORS -YES).
5. Press the SET key again, to clear the error.

NOTE:

If the recorded error is a Health Time Expired error, the error must be cleared, then the main door must be opened and shut again to reset. The merchandiser will now have 30 minutes to cool down.

If the recorded error is a Main Door Open error, make sure the main door is securely latched before attempting to clear error.

DEFAULT MENU

The DEFAULT menu contains menu items that perform machine initializations.



Machine Init

MACHINE INIT allows the machine to be initialized to a default setting.

There are three types of machine initializations; FULL and OPTIONS and FACTORY TEST.



The **OPTIONS** initialization resets all values in the OPTIONS MENU to default states. Options that can be set in the OPTIONS MENU will be turned OFF. (See section OPTIONS MENU)

To perform an OPTIONS initialization:

- 1) Use the  or  key to display "MACHINE INIT - OPTIONS" on the message center.
- 2) Press the  key.

The **FULL** initialization resets the 550 to default states. All resettable values in all menus will be reset: PRICE, MIS totals (except for the non-resettables), OPTIONS, TURRETDELAY, AUTO PRICE, and DISCOUNT. **All price and shelf configuration data will be cleared. All MIS data, except non-resettable values, will be cleared.**

To perform a FULL initialization:

- 1) Use the  or  key to display "MACHINE INIT - FULL" on the message center
- 2) Press the  key.

NOTE:



To ensure that the initialization takes effect, turn the machine OFF, and then back ON after performing the initialization.

NOTE:

Selecting any of the initialization options listed above will reset various values to default states. Do not initialize the machine unless you intend reprogram the settings.

The **FACTORY TEST** initialization configures the vendor for testing at the factory. This type of initialization is not recommended for operator use.





To perform an FACTORY TEST initialization:

- 1) Use the  or  key to display "MACHINE INIT - FACTORY TEST" on the message center.
- 2) Press the  key.

Print Baud Rate

The purpose of PRINT BAUD RATE is to set the baud rate of the printer. There are three baud rates that may be chosen. They are 9600, 2400, or 1200. The Default baud rate is 9600.

To set the baud rate:

- 1) Press the  key until "PRINT BAUD RATE-BBBB" appears on the message center.
- 2) Use the  or  keys to choose between 9600, 2400, or 1200 depending on the particular printer in use. (Check printer manual for printer baud rate)
- 3) Press the  key.

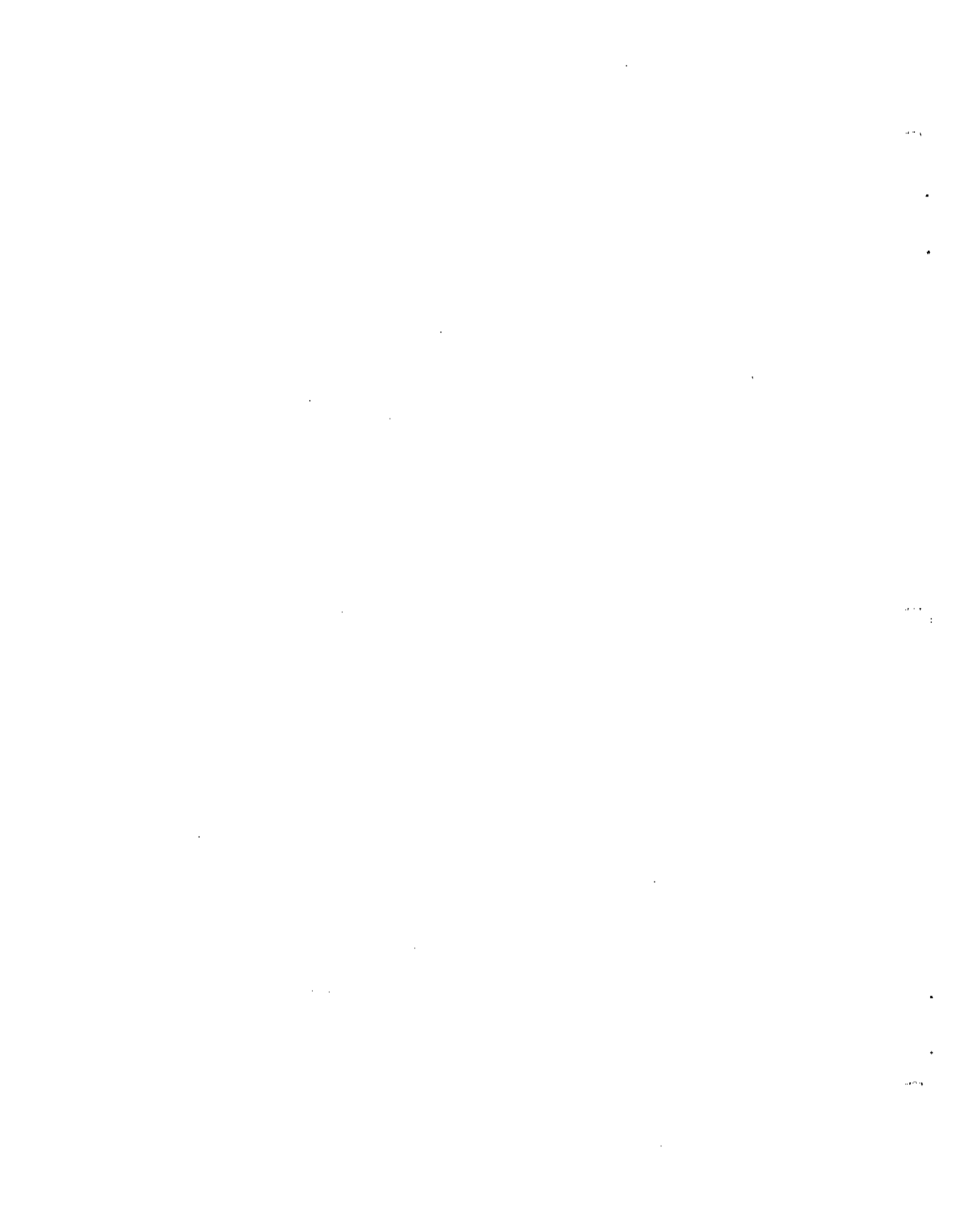

Troubleshooting Table of Contents

Introduction	4-3
Preliminary Checklist	4-3
Drive Motor Errors	4-4
Coin Mech Errors	4-4
Power Up Initialization	4-5
Troubleshooting Charts	
Error Messages	4-6
Problem / Solution	4-8
Refrigeration	4-11
Schematics	
Universal Control Board	4-12
Power Supply	4-16
Vendor	4-20
Refrigeration	4-24
Power Supply Indicator Lights	4-25

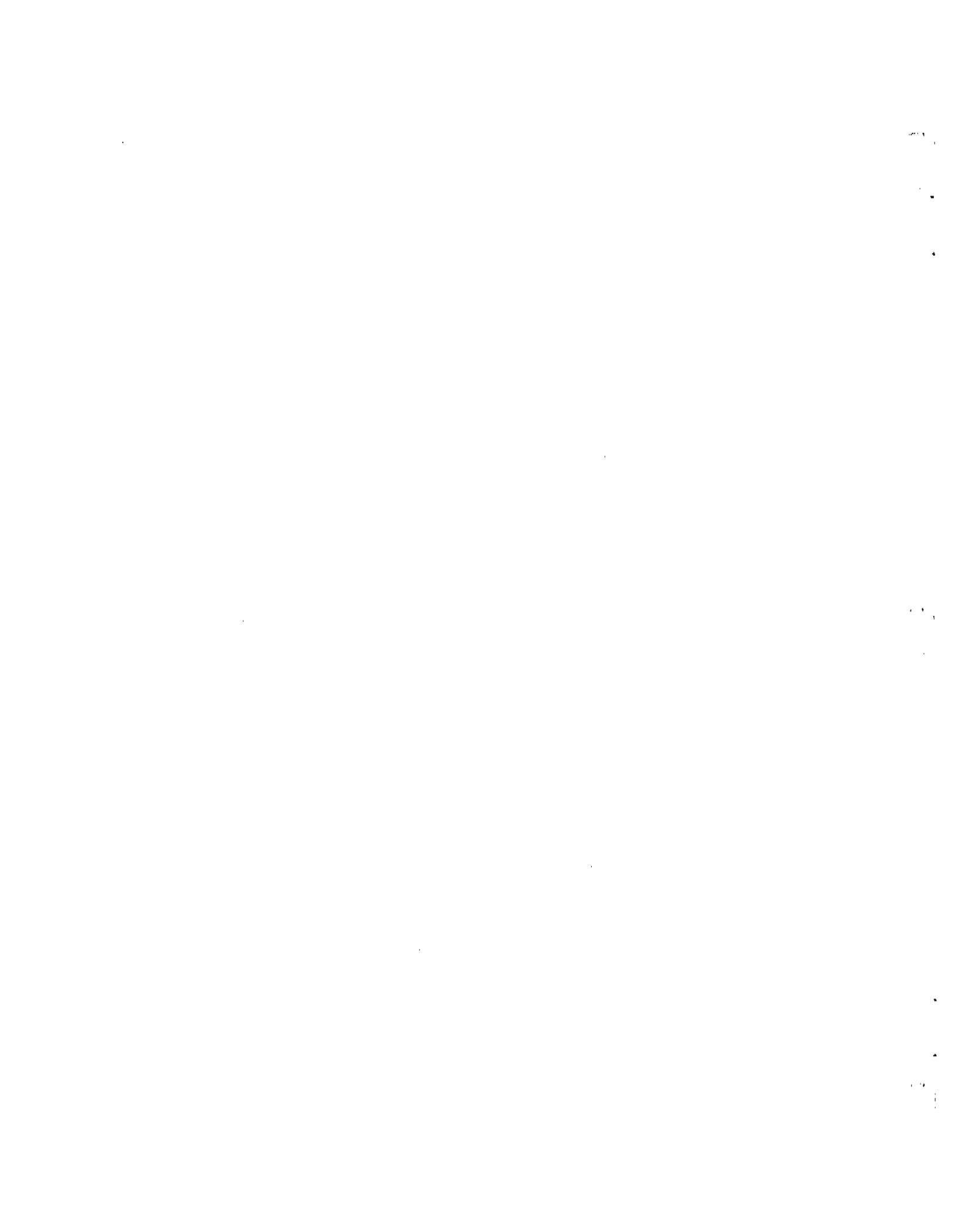

SECTION 4

TROUBLESHOOTING



INTRODUCTION

This section contains a preliminary check list and two troubleshooting charts. The first chart lists Error Messages which will be shown on the Message Display Center when in the Service Mode. The second lists possible problems and suggested solutions.

When a problem occurs, always look for the obvious solution first. Check the following before attempting to make any adjustment or replace any parts:



Check List

- ✓ Check that the merchandiser is connected to a live power source, 120V with a good ground.
- ✓ Check that the main power switch is ON.
- ✓ Check the condition of both circuit breakers on the Main Power Switch Assembly and on the power supply unit located on the sliding panel.
- ✓ Check to insure the refrigeration interlock switch is actuated when cabinet door is closed and latched.
- ✓ Check that all plugs are seated in their receptacles.
- ✓ Check that connector pins are not bent, broken or pushed through the back of the connector when mated.
- ✓ Check that wires are not broken at connector pins.
- ✓ Check all indicator LED's on UCB and Power Supply Asm.
- ✓ Check that all trays are securely connected to the carrier assemblies.

Troubleshooting Charts

Each time the Universal Control Board is powered up it performs a series of tests to determine if specific components are functioning properly. As the machine goes through its various cycles during a vend there are a number of routines which monitor the machine's performance and record any malfunctions. If a problem is encountered, an Error Message indicating the type of problem is stored in the Universal Control Board's memory. The memory is battery backed and will not be affected by routine power outages.

If an error code occurs, the machine will attempt to continue to operate normally. It should be noted however, that certain errors will make it necessary to disable some functions.

For example: If the latch reset bar solenoid fails to lock the baffles it would be necessary not to allow the conveyor to rotate. This would prevent someone from taking items out through the unlocked doors which haven't been paid for.

Error Messages

For a listing of the Error Messages see the Troubleshooting Chart - Error Messages, pages 4-6 & 4-7. To view and clear Error Messages see Service Mode Operation, page 3-3.

The 550 has self diagnosing software to identify problem conditions. The operator is alerted using error messages rather than error codes.

If an error occurs while the service door is open (service mode), an immediate temporary descriptive message is displayed. If the error occurs while the service door is closed (vend mode), the error message is added to the error queue. If there are any error messages in the error queue at the start of the service mode, they will be displayed in the order in which they occurred. The <set> key is used to advance to the next message.

After all the messages have been viewed, the operator will be given the option of clearing the message queue. If the queue is not cleared, the error messages will continue to appear each time the service door is opened, and the service mode is entered.

Out of Service

When a serious error condition occurs or exists while in vend mode, the machine will be put out of service. If there was credit established at that time, it will be returned. All of the money handling devices will be disabled. The Message Center will display "SORRY-OUT OF SERVICE" and the fluorescent lights will be turned off.

Drive Motor Errors

Upon full initialization, the drive motor zero position is reset and needs to be located. The zero position is indicated by the activation of a magnetic switch by a magnet mounted on the of the back of one of the shelves. The switch is mounted on the refrigeration duct, located in the lower portion of the cabinet. The zero position will also need to be found if any motor error occurs either in vend mode or service mode.

If the error occurred in vend mode, the machine will be put out of service, the motor will be disabled and an error message will be inserted into the error queue.

If the error happens while in service mode a temporary error message will be displayed. Another temporary error message will appear each time the conveyor motor is operated until zero position is located again.

Coin Mech Errors

The coin mech is required for machine operation in vend mode, except when free vend is active. Upon power up and each time the service door is closed, the reset line on the coin mech is toggled, which results in the coin mech sending a power-up message to the UCB. If that message is not received in the specified time period, the "COIN MECH NO REPLY" message will be displayed. The machine will be put out of service if this occurs in vend mode. The probable cause of this error is that the coin mech is not plugged in.

During the service mode, the coin mech is enabled at all times and coins should be accepted. If coins are not being accepted, make sure the coin mech is receiving power from the power supply by pressing the coin payout buttons and listening for the solenoids to energize. If none of the solenoids are energized, examine the power connections in the coin mech harness. If the solenoids do energize but the coin mech is not accepting coins in service mode, examine the accept-enable connections in the coin mech harness.

Initial Power Up

The Message Center will display a "SELF TEST OK" message upon power up. The display will remain unchanged until the Universal Control Board sends it a message. If the Message Center fails to "light up", the Message Center harness should be tested to ensure that power is being supplied.

When the UCB software starts up, it sends a 550 software revision identification message to the Message Center for a few seconds. Following this, the display will read "AMBIENT MACH" or "REFRIGERATED MACH". Make sure that this display matches the type of machine you have. The display will then change to service menu, assuming that the service door is still open. The price displays will then receive the compartment prices.

The TEST LED on the Universal Control Board will begin to flash, indicating that the processor is running. In general, the LED should always be flashing; though there are times when it will stop flashing momentarily during certain normal processing.

If the power up message of either display remains after the UCB TEST LED begins flashing, then there is no communication between the UCB and that display and the harness should be examined.

Power-Up Initialization

The UCB features 8 Kilobytes of battery backed up RAM enabling the software to "remember" the state of the 550 if power is interrupted for any amount of time.

The advertised life of this battery is 10 years. When power to the machine is restored, the prices, options, MIS information etc. are the same as when the power was lost.

Each time the UCB is powered up, two tests are executed to determine if initialization is necessary. One test examines two memory locations for a specific test pattern. The other test performs a memory checksum calculation on most of the code section of UCB EPROM. If either test fails, a full

software initialization will take place. This should also occur each time a new EPROM is installed.

After initialization, all options are disabled, MIS information is cleared, the prices are set back to default etc. The default prices for each price schedule is 50¢ for all selections.

The operator may also manually initialize the machine via the Default service menu. There are three types of initialization available; options and full and factory test. The options initialization will initialize all the options found in the Options menu to their default state. **The full initialization will reset all machine settings to factory defaults except non-resettable MIS totals, which will not be cleared.** The factory test initialization will establish a set of prices and compartment configurations used for testing the vendor at the factory. **The factory test initialization is not intended for use in the field.**

Coin Mechanisms

120 VPDC Models - 12 or 15 Pin
 MARS TRC - 6000
 COINCO 9300L

24 VPDC Models - 15 Pin Only
 MARS TRC - 6010 - XV
 COINCO 9302LF

CAUTION !

Do not use a 24 volt Coin Mech with a 12 pin plug. This will result in permanent damage to the Coin Mech and / or the vendor

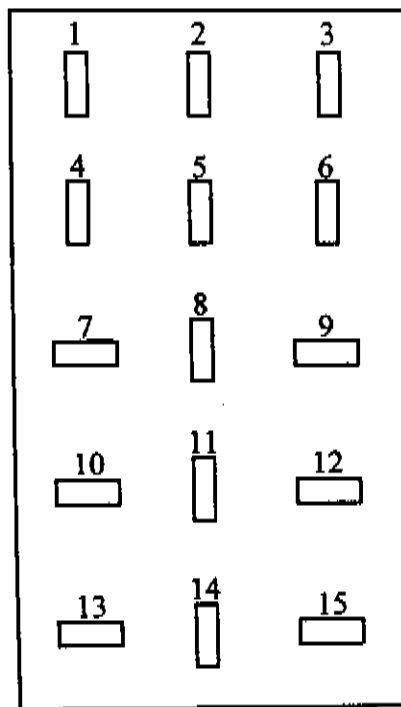

- 1. +5 VDC
- 2. 5V RTN
- 3. Send
- 4. Int
- 5. Data
- 6. Accept Enable
- 7. Dis \$.25
- 8. Dis \$.10
- 9. Dis \$.05
- 10. -120V PDC
- 11. Reset
- 12. +120V PDC
- 13. -24V PDC
- 14. Dis \$1
- 15. +24V PDC

**15 Pin
 Coin Mech Socket**

Troubleshooting Chart Error Messages

ERROR MESSAGE	PROBABLE CAUSE	SOLUTION
"HEALTH TIME EXPIRED"	Refrigeration unit not plugged in	Check and replug
	Refrigeration screen on condenser clogged	Check and clean
	Refrigeration relay disconnected or defective	Check and/or replace
	Machine too close to the wall	Move away from wall at least 6"
	Main door not closed tightly	Check and readjust latches
	High ambient temperature	Vendor not designed to operate outside
	Temperature reads 96° F continuously	Temperature Sensor not plugged in, or defective
"MAIN DOOR OPEN"	Machine not in refrigerated mode	Place dip switch #2 in the ON position.
	Switch not activated	Check Main Door and switch adjustment
	Switch broken or defective	Replace switch
"OPTO SWITCH ERROR"	Switch disconnected	Check wiring
	Conveyor Motor jammed error, return to zero position	Clear jam, clear motor
	Conveyor overloaded	Clear jam, clear motor
	Shorted motor leads	Remove short, clear error, turn to zero position
	Bad driver circuit on Power Supply	Replace power supply
	Bad detection circuit on Power Supply	Replace power supply

Troubleshooting Chart Error Messages Continued

ERROR MESSAGE	PROBABLE CAUSE	SOLUTION
"OPTO SWITCH ERROR"	Opto Switch disconnected or defective	Check wiring at Opto Switch Replace Switch
	Motor Interlock Switch disconnected or defective	Check wiring at Motor Interlock Switch Replace Switch
	Opto Switch signal to Controller disconnected or defective	Check I/O Cable between Power Supply P11 to Controller board P3
"ZERO POSITION ERROR"	Unable to locate zero position	Check Zero Position Switch, wiring, and magnet
	Machine initialized, no zero position located	Same as above
	Possible Motor Error	Check Motor wiring connections
	UCB unable to monitor conveyor movement	Check Half Cycle Switch on motor
"LOCKBAR SWITCH ERROR"	Bad lockbar switch	Check lockbar switch wiring Replace Switch
"LOCKBAR SOL ERROR"	Bad lockbar solenoid wiring	Check wiring for lockbar solenoid
	Defective Solenoid	Replace Lockbar Solenoid
"DEFECTIVE SENSOR MSG"	Defective coin tube sensor	Check Coin Mech Replace Coin Mech
"COIN JAM MSG"	Coin lodged between acceptance gates.	Check and clear jam Clean Flight Deck Replace Coin Mech
"NO STROBE MSG"	Valid coin has been recognized but not detected passing through to the inventory tubes or to the cash box.	Check for blockage in Coin Mech Replace Coin Mech
"COIN MECH NO REPLY"	Coin mech unplugged or defective coin mech	Check Coin Mech Connection Replace Coin Mech

Troubleshooting Chart (Problem / Solution)

PROBLEM	PROBABLE CAUSE	SOLUTION
Message Center does not light	No power to the Message Center	Check for +5 VDC Check for -24 VDC Check for VRTN Above voltages are required for the Message Center to light. There is only one cable to the Message Center. This comes from the Controller Board. If the Controller dies but power is still on the Message Center, the Message Center will default to the built in message "ROWE INT'L VERX.XX"
Price display does not light	Missing Power	Check Power Supply -24V FIL-OUT light indicator
	Harness/Connector Problem	Check from P/S (P4) to Display (P1)
	Defective Price Display	Replace
Does not accept coins	Missing Power	Check Power Supply 120 VPDC Light Indicator
	Harness/Connector Problem	Check Coin Mech Socket, UCB (P8) and P/S (P12)
	Defective Coin Mech	Replace
Does not attempt acceptance	Missing Power	Check power light on Power Supply
	Coin Mech change level low	Add change to Coin Mech
	Improper coin loading technique	See Coin Loading routine page 3-12
	Harness/Connector Problem	Check I/O UCB (P5) to B/A (P2 - P3)
	Bill Acceptor not enabled	Check Options Menu program on page 3 - 21 to see if B/A is enabled
	Defective Bill Acceptor	Replace

Troubleshooting Chart (Problem / Solution)

PROBLEM	PROBABLE CAUSE	SOLUTION
Does not register credit	Credit messages not received from Coin Mech	No continuity between J8 pin 9 of UCB and pin 5 of Coin Mech plug
	Coin Mech defective	Replace Coin Mech
	Service Door switch not closed	Check for defective actuator
Does not give change	Coin Mech mis-programmed	Reload Coin Mech. See page 3 - 12 Set Coin Tubes
	Dispense lines to Coin Mech disconnected	Check continuity between: <u>Controller J8</u> <u>Coin Mech</u> pin 3 pin 9 pin 4 pin 8 pin 5 pin 7 pin 7 pin 14
	Defective controller board	Replace controller board
	Dollar coins in MIS	Empty dollar coins
Conveyor does not rotate	Harness/Connector problems	Check terminals on Motor Check P/S (P9 pin 1 & 3) YL/BK & RD/ BK wires to motor terminals Check P/S (P9 pins 6 to 8) Check UCB (P2) to Message Center
	No signal from Message Center	Replace defective Message Center
	UCB ON/OFF output signal missing	Measure P/S (J3 pin 4) to (P11 pin 4 ground) for 12 VDC with Service Switch ON Replace UCB if missing voltage Replace P/S if voltage is present
	Conveyor overload or jammed	Remove obstruction
	DC Motor defective	Check for 24VDC across motor, if present, replace
Conveyor only turns one direction	Key Stuck on Message Center	Disconnect harness. If conveyor stops replace Message Center
	Service Switch defective or shorted to door	Check Switch Perform continuity test between switch and door chassis for wire short

Troubleshooting Chart (Problem/Solution)

PROBLEM	PROBABLE CAUSE	SOLUTION
Conveyor only turns one direction	UCB Dir output signal missing	Measure across P/S (P3 pin 15) to (P7 pin 1 ground) for 12 VDC Replace UCB if missing voltage Replace P/S if voltage is present
	Harness/Connector problems	Check UCB P3 to P/S P11, WH/YL wire for continuity
	Message Center Rocker Sw. defective	Replace message Center
Conveyor Rotates constantly	Key stuck on Message Center	Disconnect harness from Message Center, if conveyor stops replace Message Center
	Service Switch defective or shorted to door	Check Switch Perform continuity test between switch and door chassis for wire short
	Half cycle switch defective, or wiring defective	Check switch for adjustment and wiring for continuity
Vend Door does not open	Conveyor out of position	Check Conveyor position Set Zero Position routine in the Diagnostic Menu. Reprogram Shelf Mode
	Compartments in sold condition	Rotate the Conveyor one full revolution with inside Service Switch
	Invalid section lockout	Check the Prohibit Vend Program in Options Menu. See page 3 - 24
	Defective solenoid	Replace Solenoid
	Defective door switch	Replace Switch
	Missing VSOL from Power Supply	Check P/S VSOL indicator light Replace Power Supply
	Defective solenoid driver on UCB	Replace UCB

Troubleshooting Chart Refrigeration

PROBLEM	PROBABLE CAUSE	SOLUTION
Health Control shutdown	Temperature Probe defective	Press Button #1 + Button #2 on the horizontal selection panel to display the temperature. If actual temperature is different from display, replace Temperature Probe
	Machine not in correct Refrig/Ambient mode	Place Dip Switch #2 on the UCB FF for Ambient, ON for Refrigerated
	Evaporator Freeze up	Make sure unit is level
	Refrigeration problem	See following Troubleshooting problems
Refrigeration inoperative	Refrigeration unplugged or no power	Check and replug
	Refrigeration relay unplugged	Connect Refrigeration relay
	Refrigeration overload	Clean screen and condenser coils
	Relay (control) defective	<p>Perform the following: Power Unit OFF. Short together the (BK) and (BR/YL) wire on the Refrig. Relay Power Unit ON</p> <p>If (A & B) hold true, replace the Refrigeration Relay: A. (Power Supply Asm.) Refrig. Relay lamp is lit. B. Refrigeration Unit now powers up.</p>

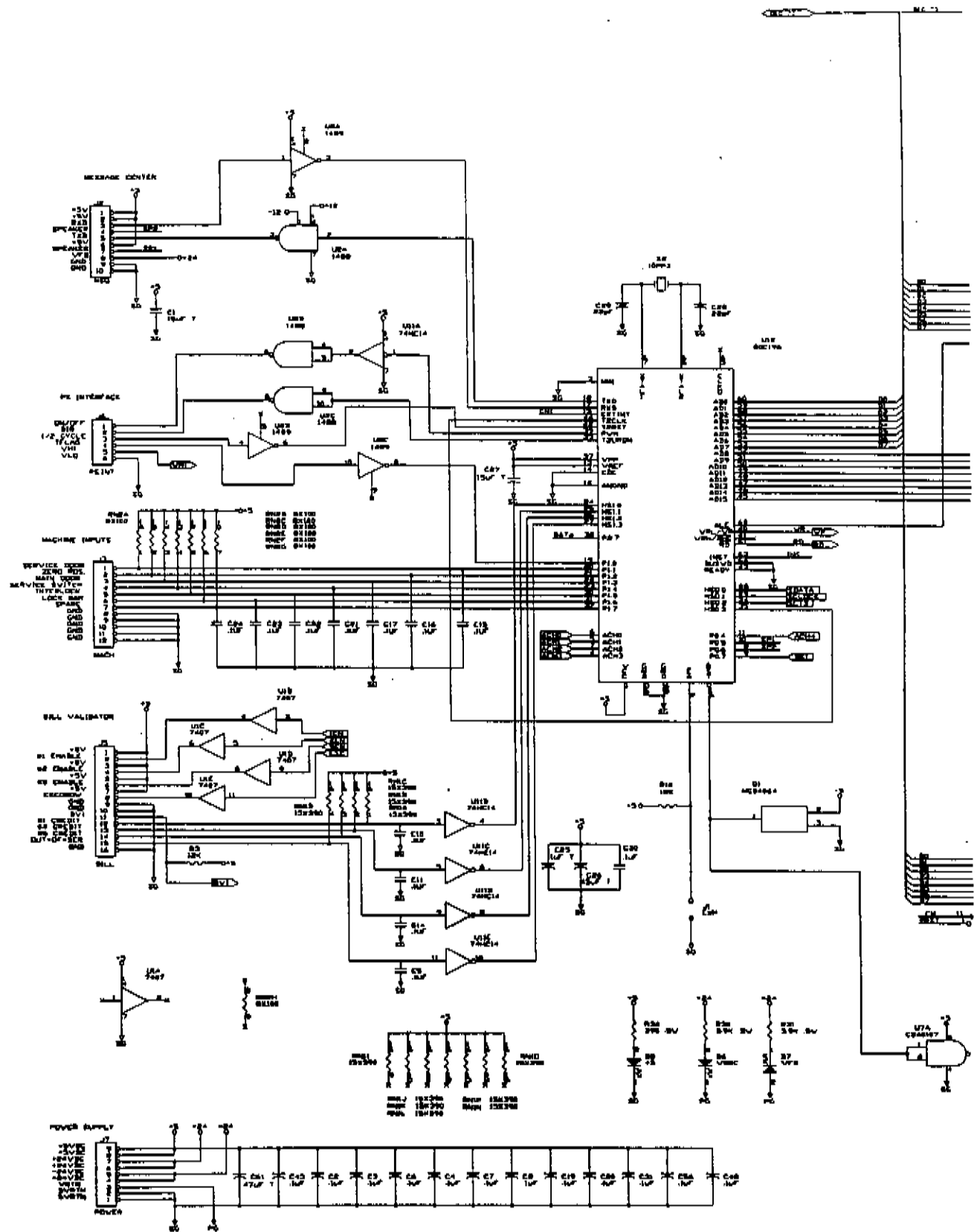

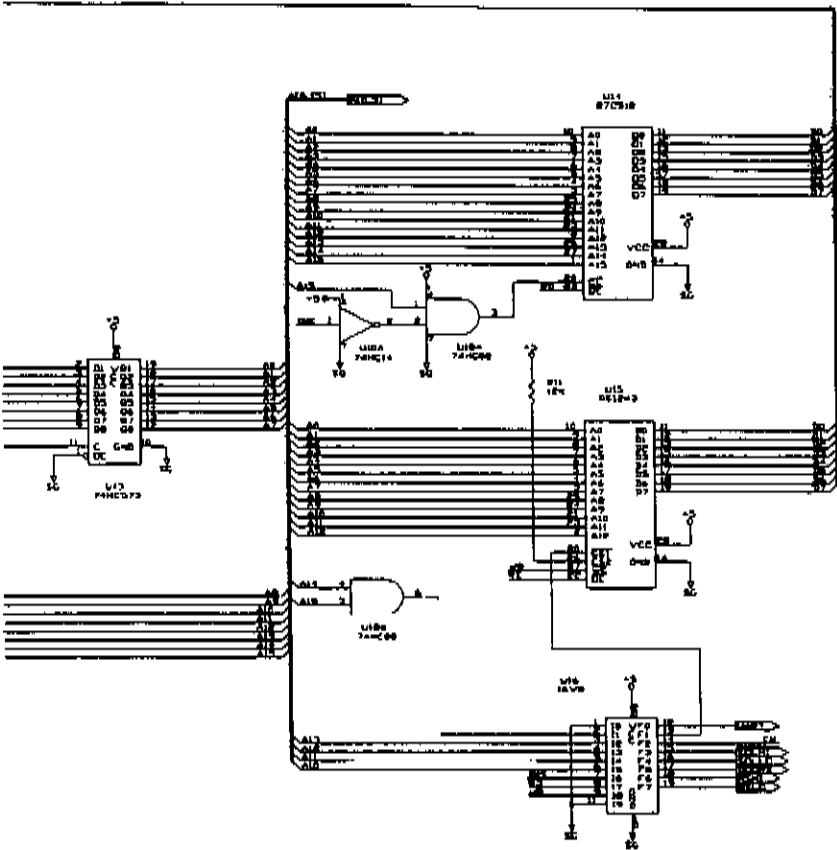

LAST USED	
U14	74
U15	75
U16	76
U17	77

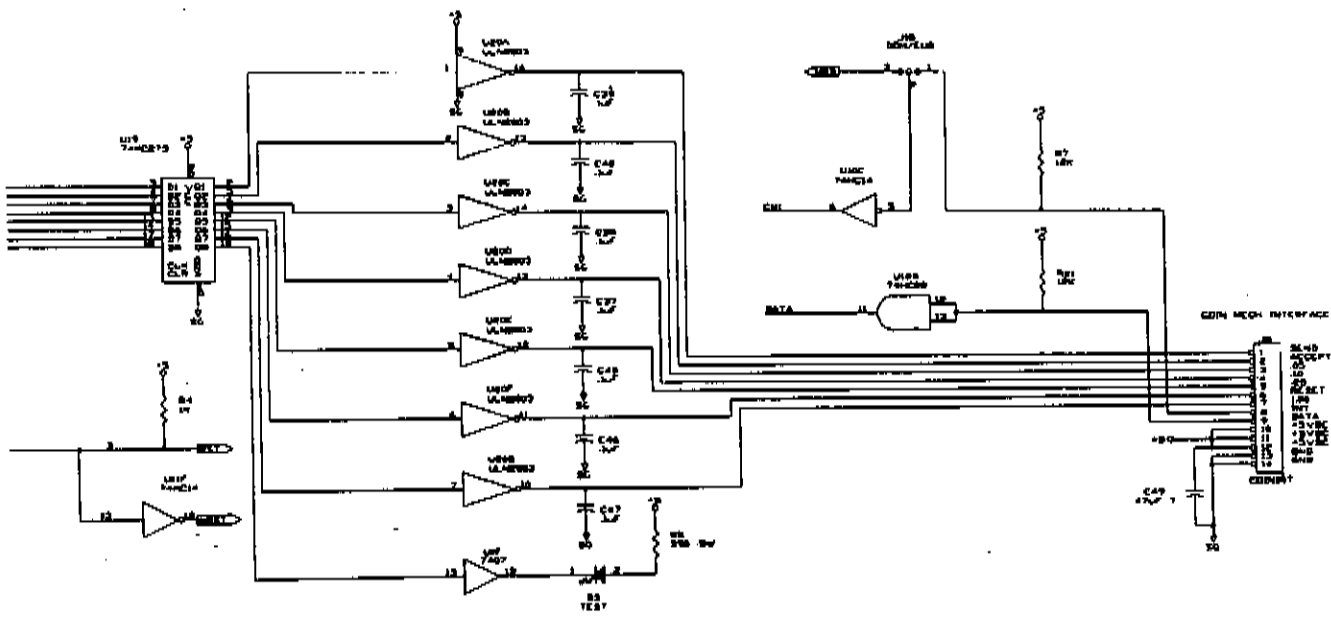

Universal Controller Schematic

P/N 280-29500 Page 1

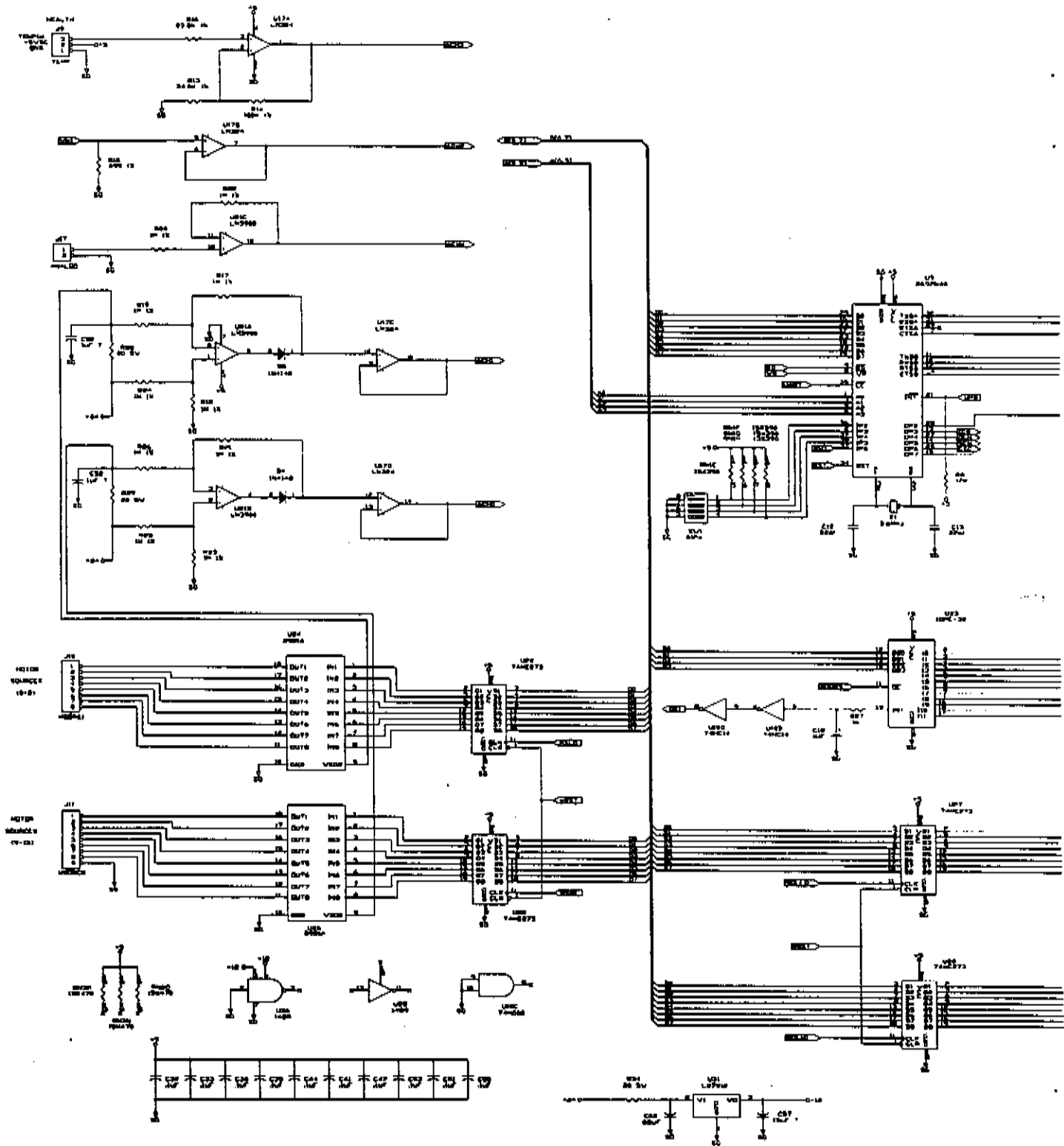

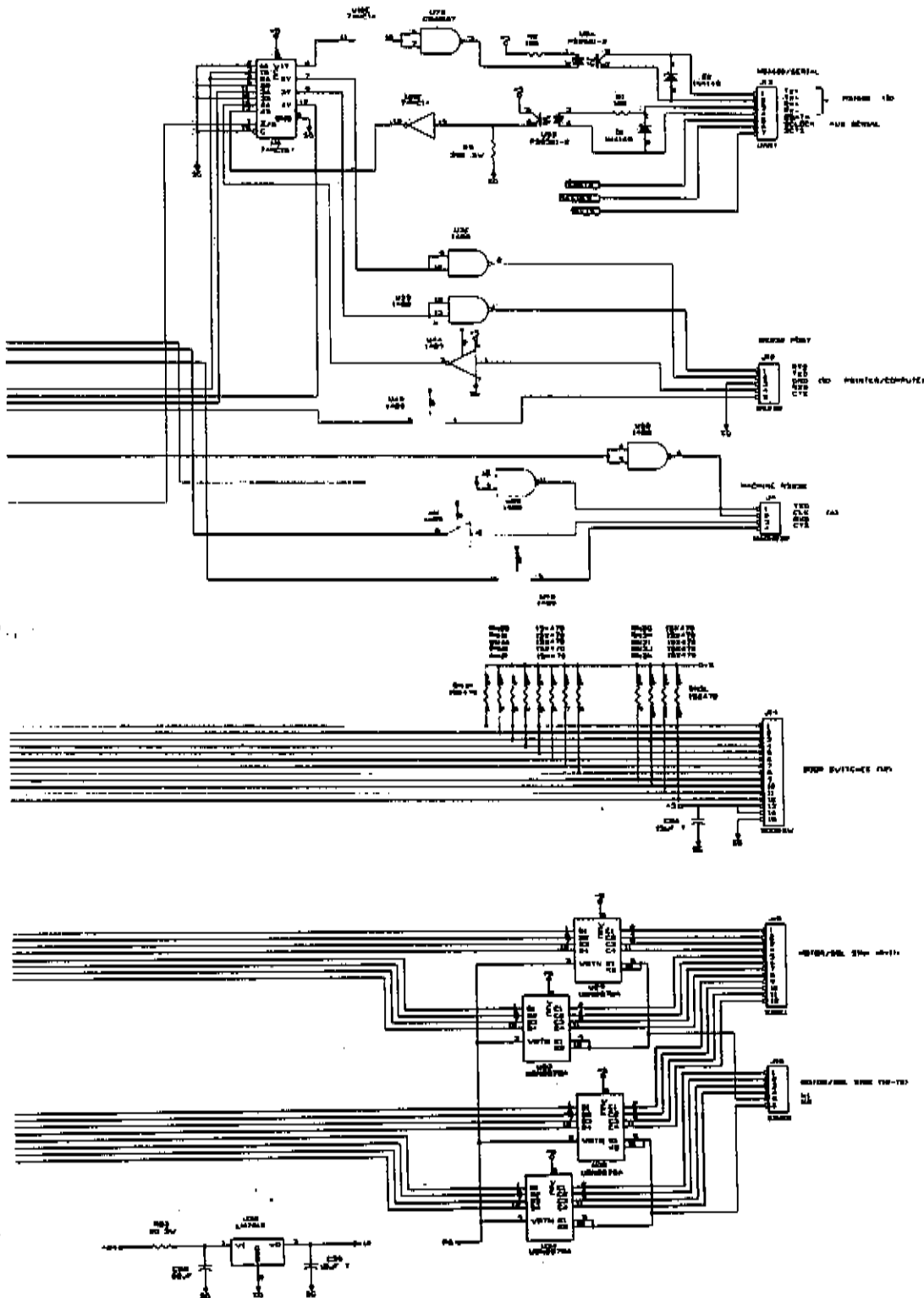

Universal Controller Schematic

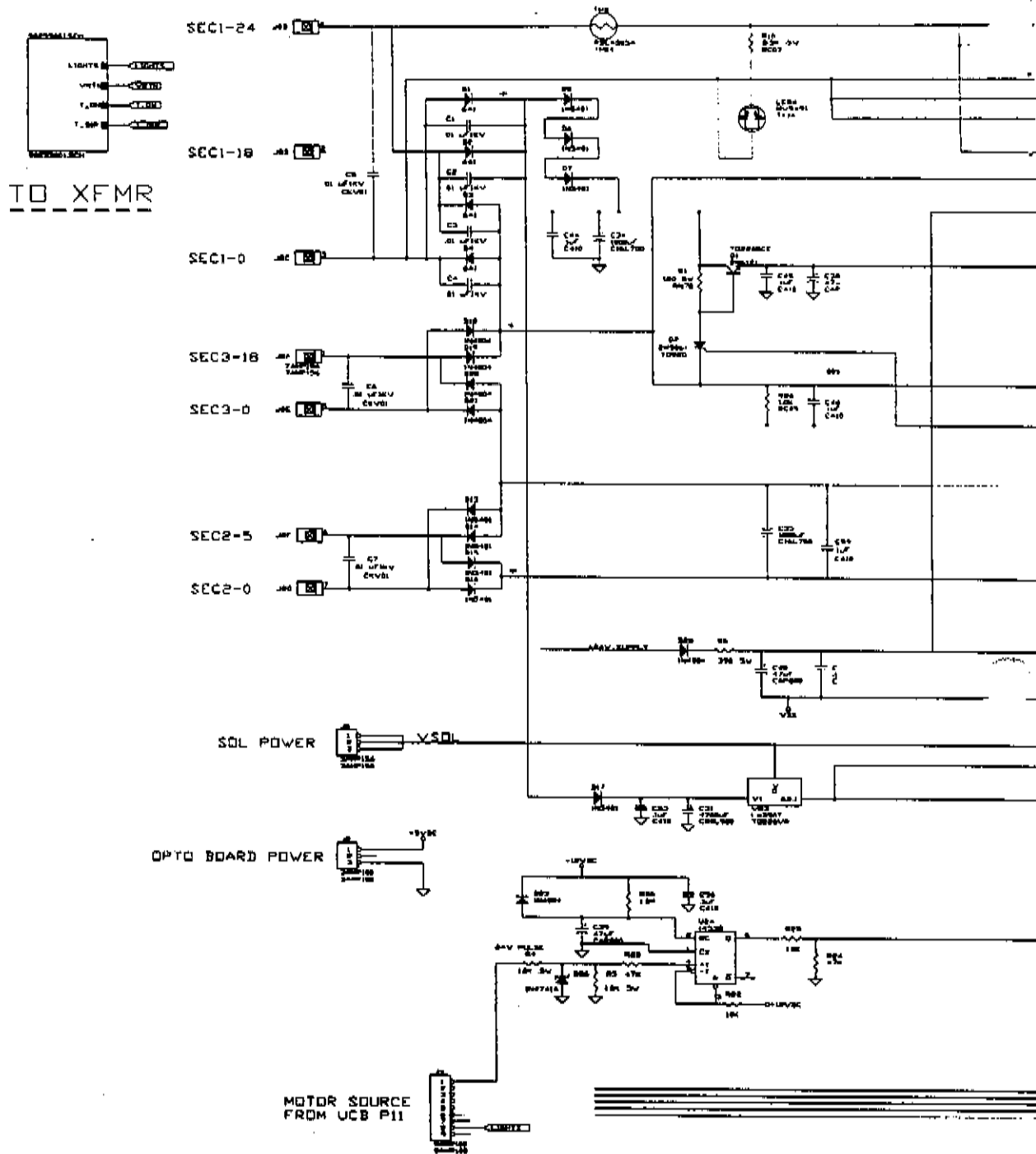

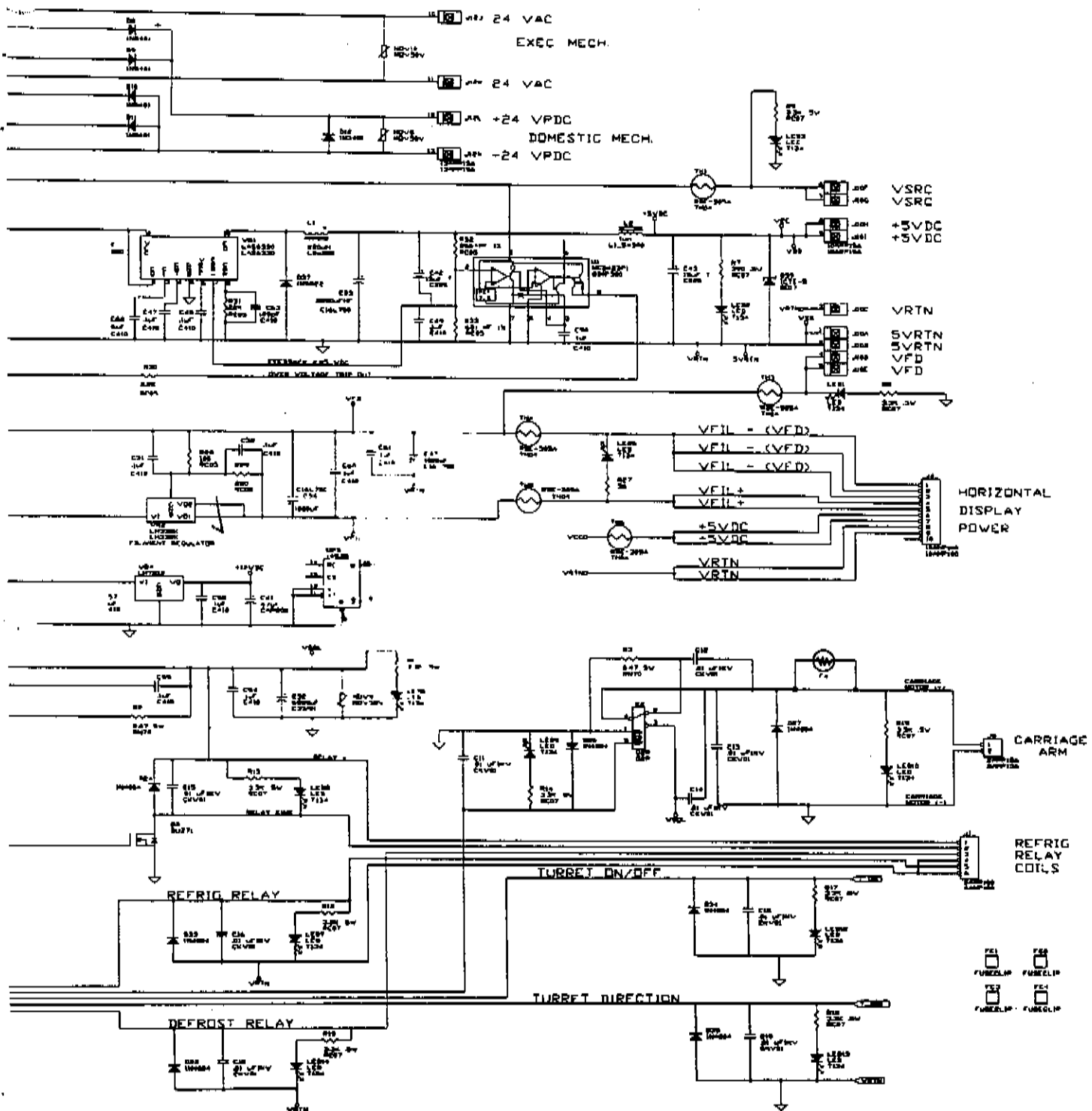

Power Supply Schematic

P/N 280-41900 Page 1

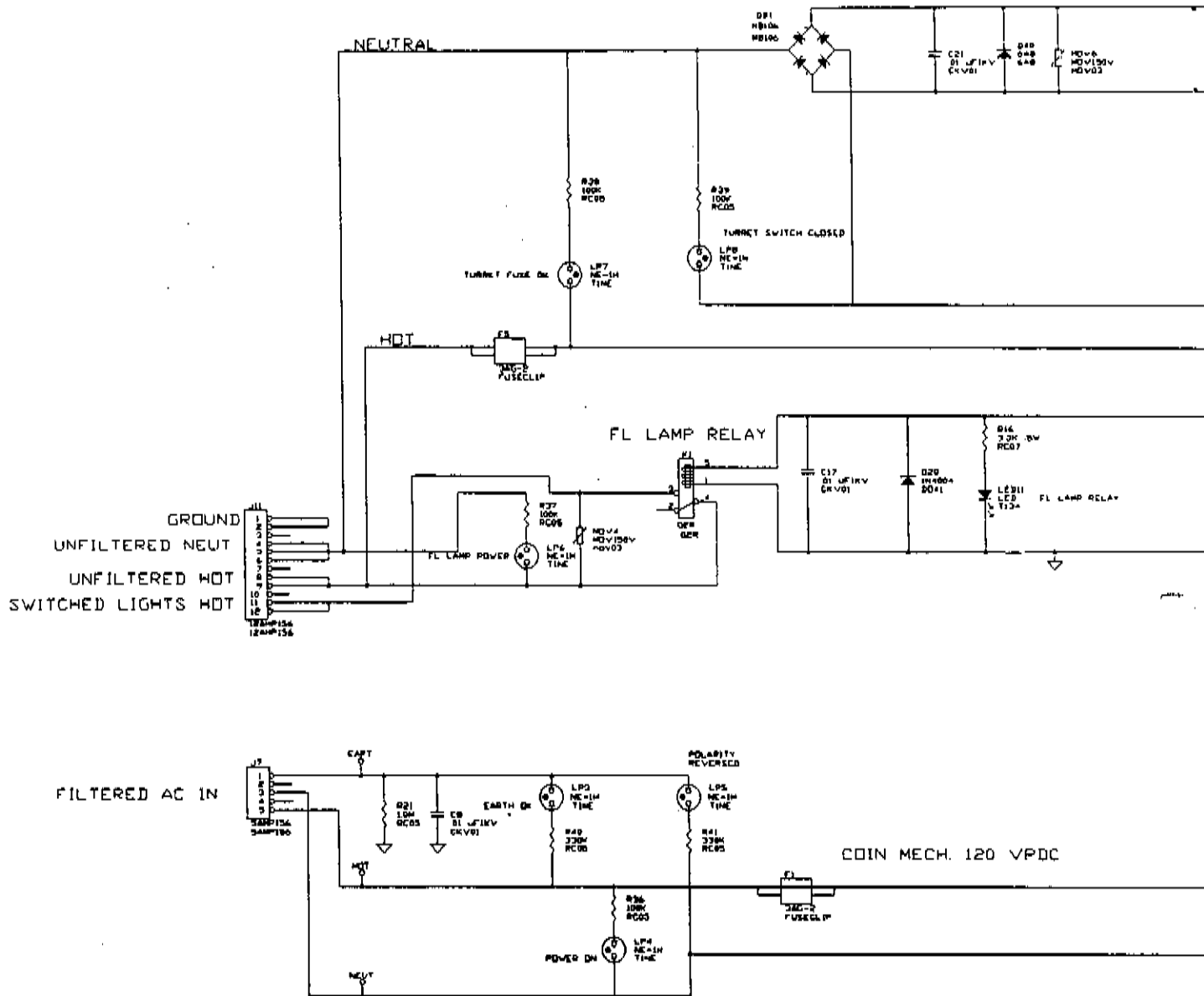

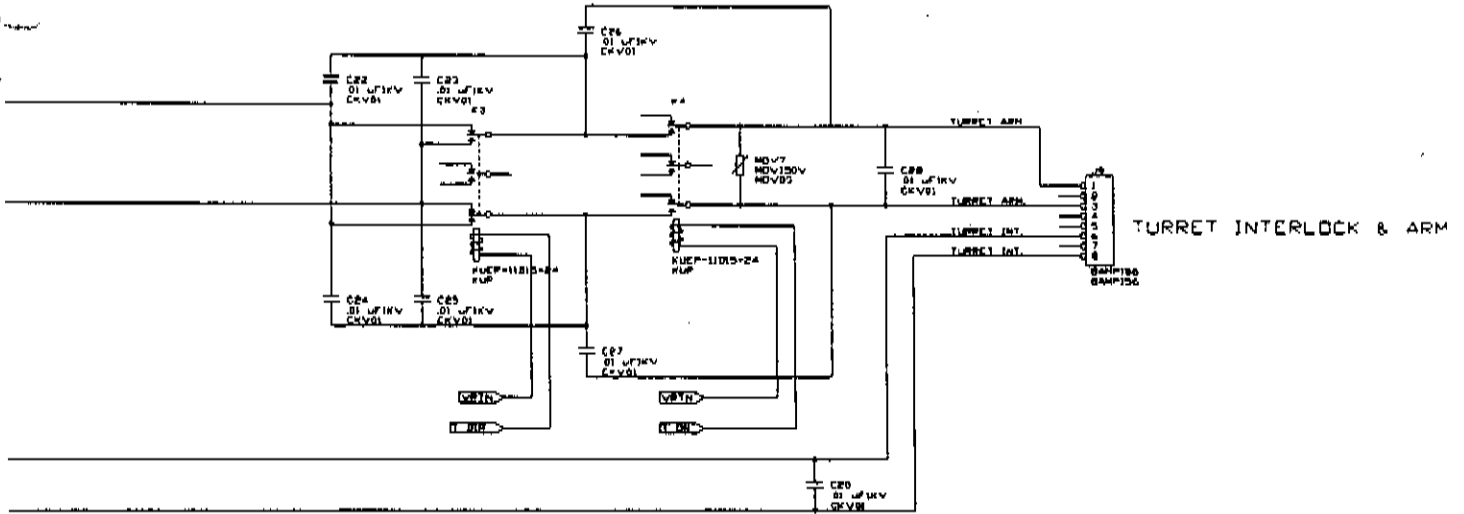

FL LAMP 41 21 03IVE

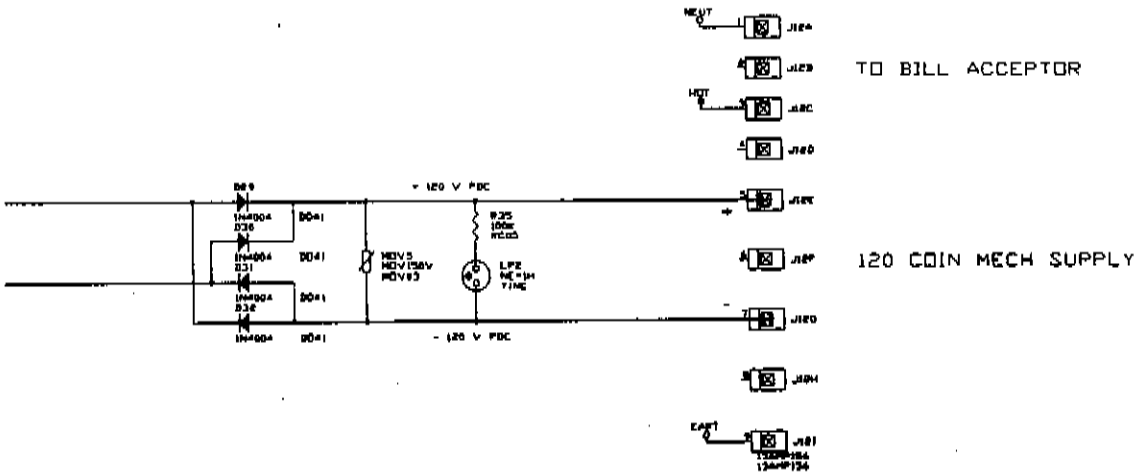

Power Supply Schematic

P/N 280-41900 Page 2

550 General Merchandiser

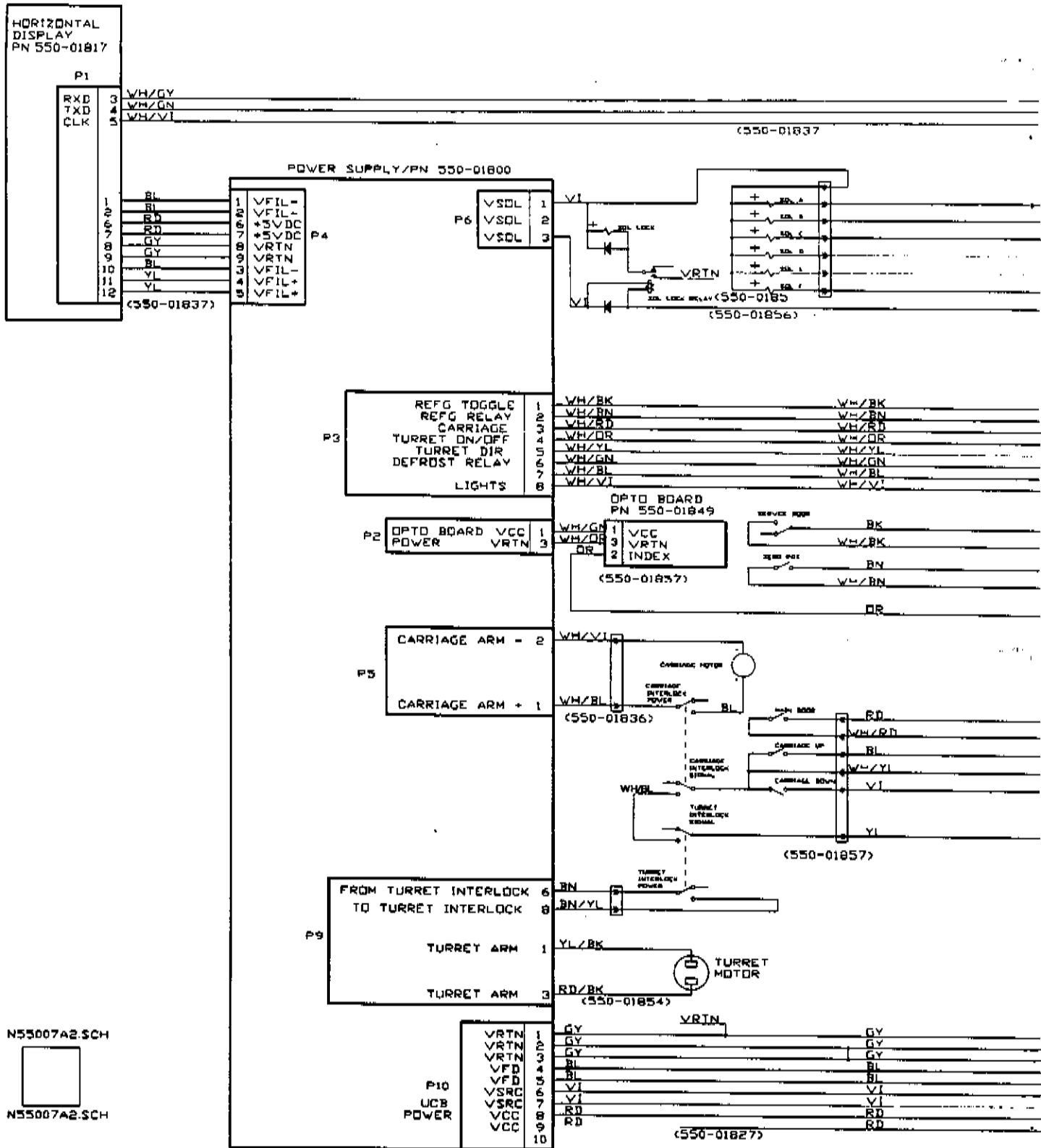

CONTROL BOARD/PN 500-01000-009

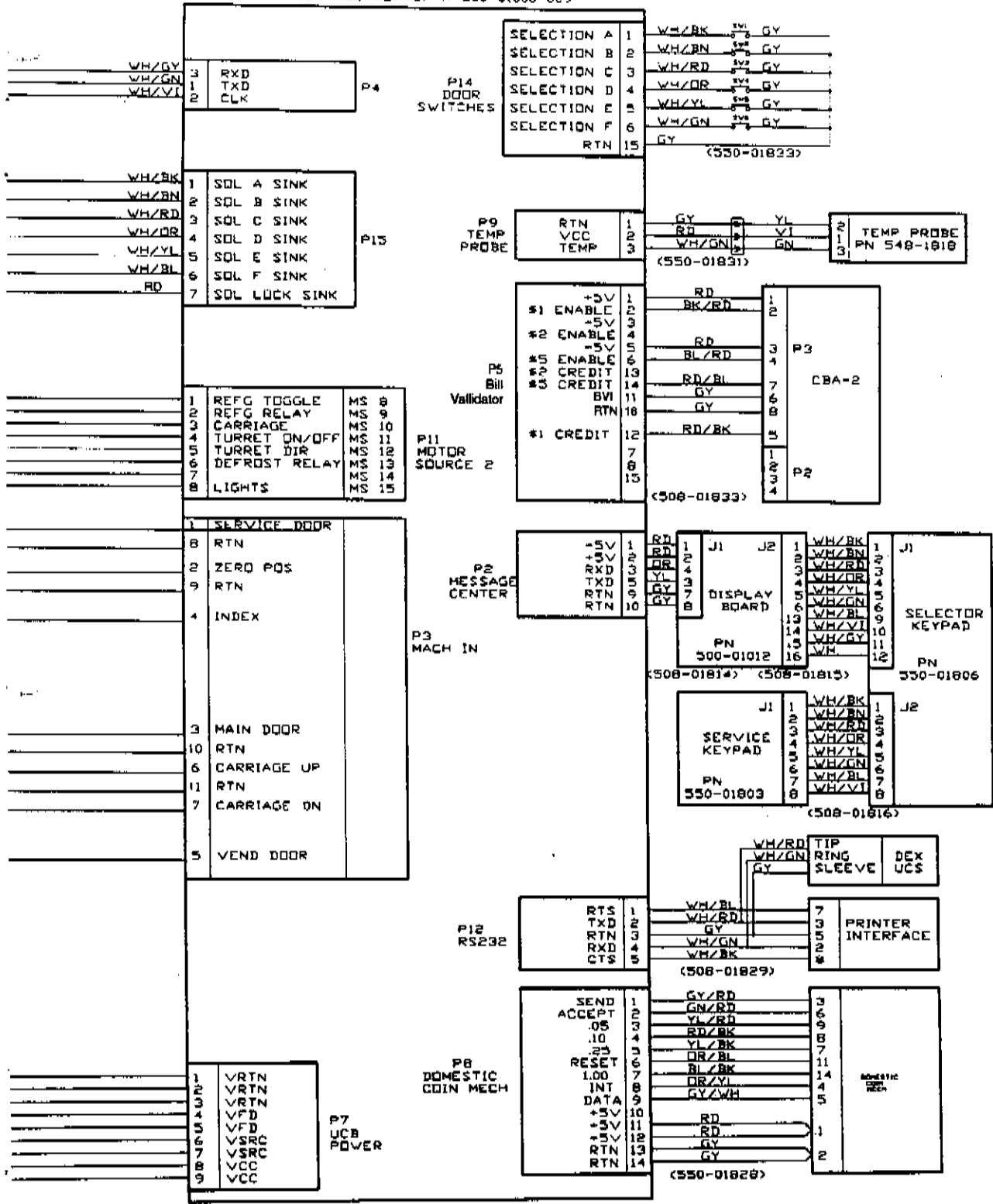

Vendor Schematic
P/N 900-55007 Page 1

550 General Merchandiser

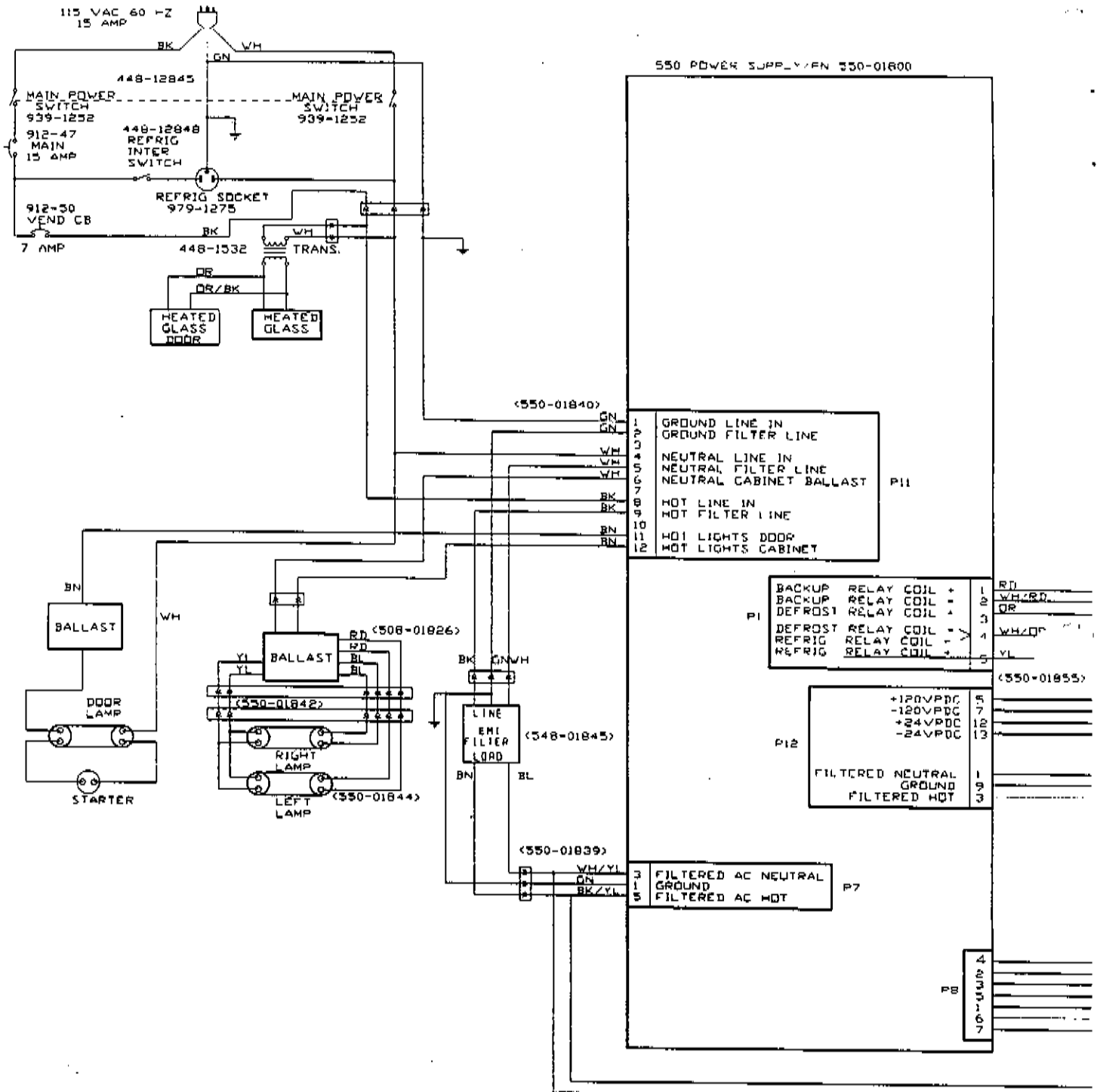

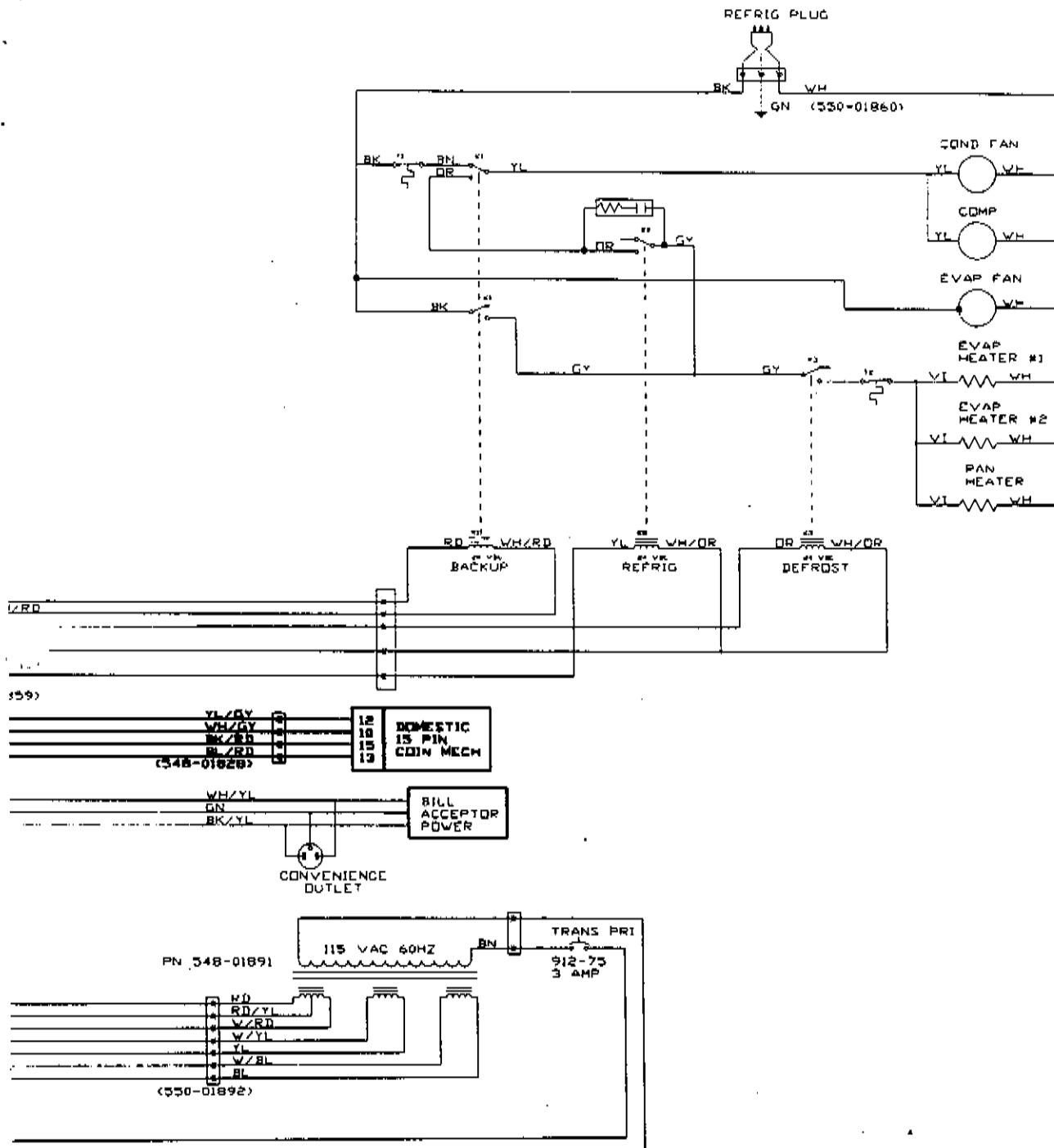

Vendor Schematic
P/N 900-55007 Page 2

Refrigeration Schematic

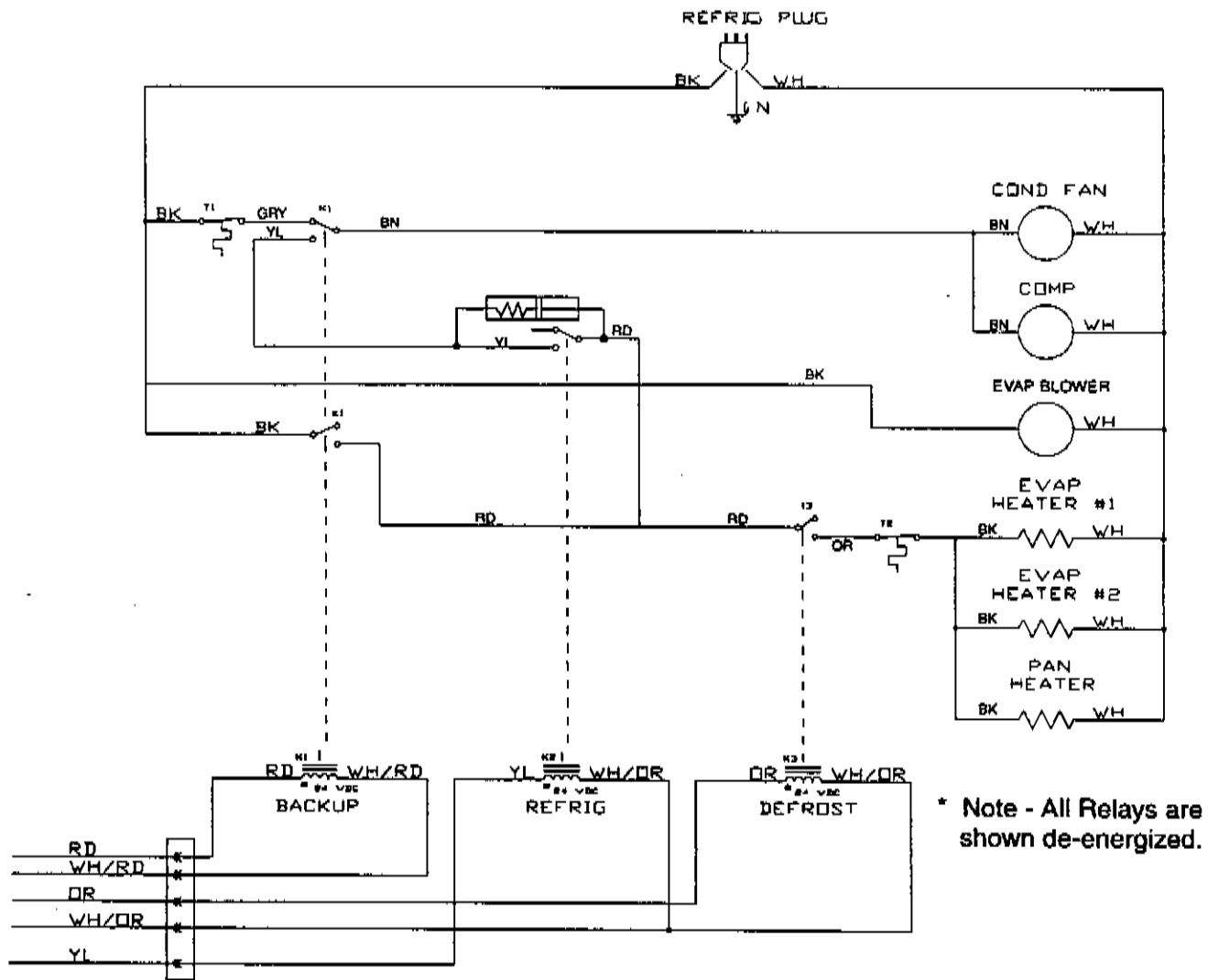

Power Supply Indicator Lights

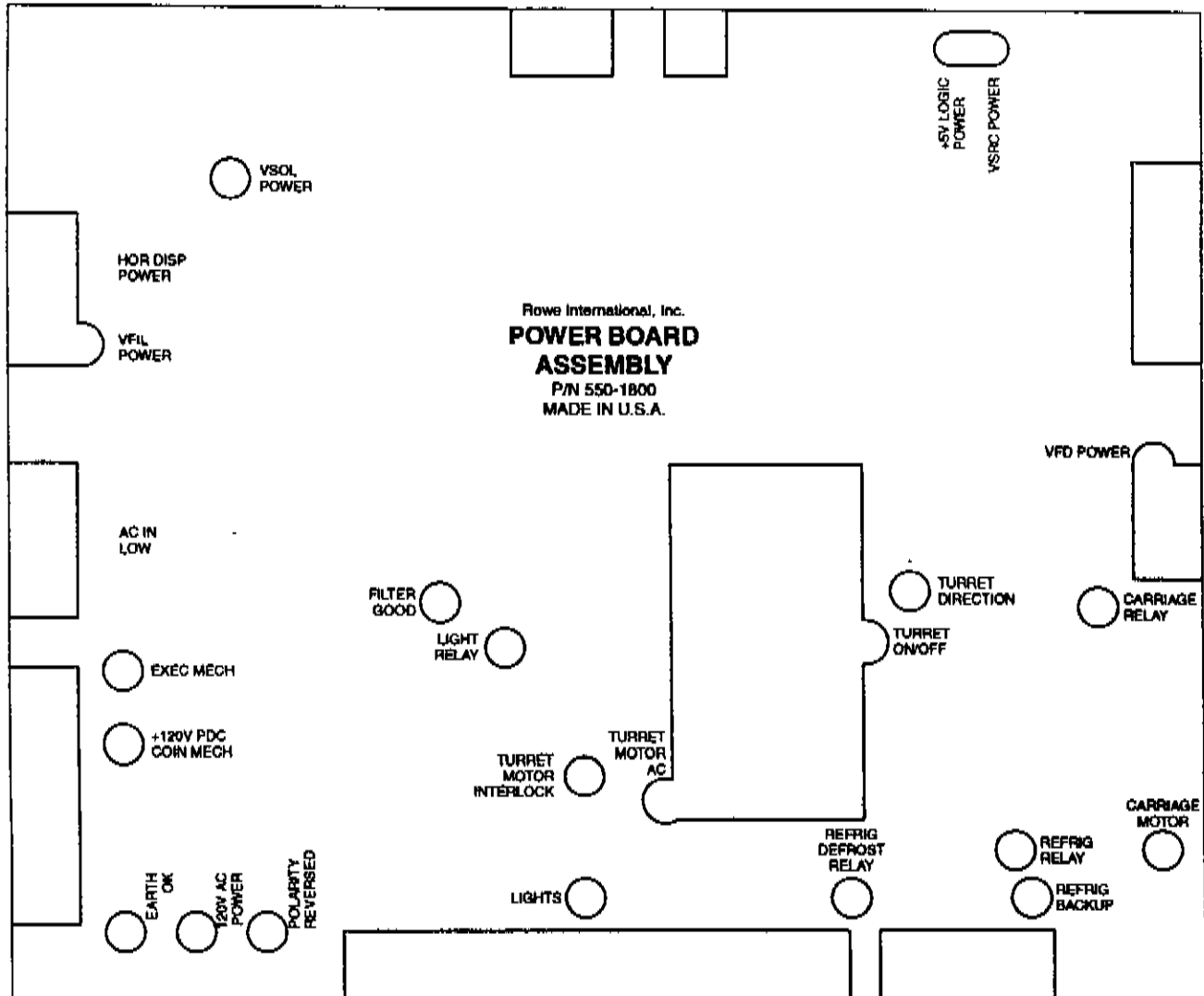

Indicator Name	Function
VSOL Power	Green LED should be ON. Solenoid power & carriage motor power.
+5 Logic Power	Green LED should be ON.
VSRC Power	Green LED should be ON. +24V power to UCB.
VFIL Power	Green LED should be ON. Power for displays.
VFD Power	Green LED should be ON. Negative power to UCB.
Filter Good	Neon lamp should be ON. Filter in power supply is good.
Light Relay	Red may be ON or OFF. If ON, relay for lights is good.

550 General Merchandiser

Turret Direction	Red may be ON or OFF. If ON, shelves will travel UP.
Turrett ON/OFF	Red may be ON or OFF. If ON, shelves should be moving.
Carriage Relay	Red may be ON or OFF. If ON, relay for carriage motor is ON.
Carriage Motor	Red may be ON or OFF. If ON, carriage motor is powered.
Exec Motor	Orange should be ON. 24 VAC for exec mech.
+120 PDC Coin Mech	Neon should be ON. Power for coin mech and bill acceptor.
Turret Motor Interlock	Neon may be ON or OFF. If ON, the vend door interlock is closed and the shelf motor may run.
Turret Motor	Neon should be ON. Power for the shelf motor.
Earth OK	Neon should be ON. Electrical ground is good.
120 AC Power	Neon should be ON.
Polarity is Reversed	Neon should be OFF. If ON AC power is mis-wired.
Lights	Neon should be ON. 120VAC Power
Refrig. Defrost Relay	Red may be ON or OFF. If ON refrigeration is in defrost.
Refrig. Relay	Red may be ON or OFF. If ON, refrigeration compressor is ON.
Refrig. Backup	Green LED Should be ON. Dead man status.

SECTION 5

MAINTENANCE



Introduction

This section will explain how to perform routine maintenance, make necessary adjustments and replace key components on the 550 General Merchandiser.

Cleaning

To maintain the beauty of the Merchandiser and project the best selling image to the customer it is important to keep the Merchandiser clean.

- 1) The display window should be cleaned, inside and out, with a good glass cleaner, using clean soft cloths or paper towels.
- 2) Painted metal and vinyl surfaces can be cleaned with warm water and mild detergent.
- 3) The shelves and shelf partitions should be cleaned at every servicing. The shelves should be removed from the machine, and the partitions removed from the shelves for best results. See figure 5-1.
- 4) Check the coin paths regularly to make sure they are clean and dry through the coin mechanism.
- 5) Check the drive chains regularly to make sure they are tight and free of debris.

WARNING!
Rotating the conveyor with the trays removed could result in damage to the drive mechanism.

Shelf Removal and disassembly

Figure 5-1, below, describes how to remove the shelf assemblies from the machine and remove the partitions from the shelves. Reassembly is accomplished by reversing the steps below.

FIGURE 5-1

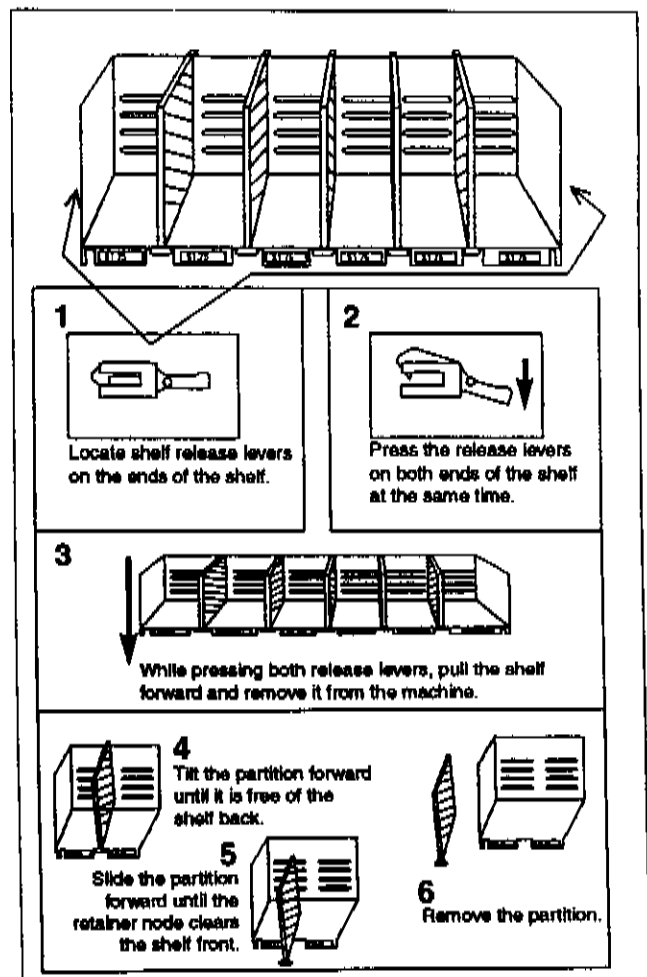

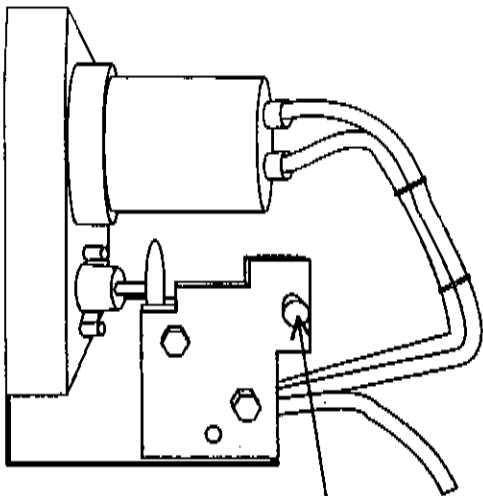

Drive Assembly

The drive motor has one adjustment knob that is used to adjust the stopping position of the shelves. To make the shelves stop higher, in relation to the delivery door, turn the adjustment knob clockwise. To make the shelves stop lower, turn the adjustment knob counter-clockwise.

To adjust the stopping position of the shelf adjust this knob.

- Turning the knob clockwise will cause the shelves to stop higher.
- Turning the knob counter-clockwise will cause the shelves to stop lower.

Drive Assembly Alignment

In order for the machine to operate properly, the product shelves must be precisely aligned, horizontally. The drive chains must be placed on the right and left drive sprockets in identical relative positions on both sprockets. To do this, follow the directions below.

- 1) With the shelves and carrier assemblies removed, rotate the sprockets so that the alignment holes on the upper drive sprockets are in the 12 o'clock position.
- 2) Ensure that the set-screw securing the motor cycle cam is facing the rear of the cabinet.
- 3) Place the drive chains on the upper drive sprockets so that a pair of carrier mounting pins is centered above the alignment hole in the drive sprocket.
- 4) Attach the carriers and shelves to the drive chains.

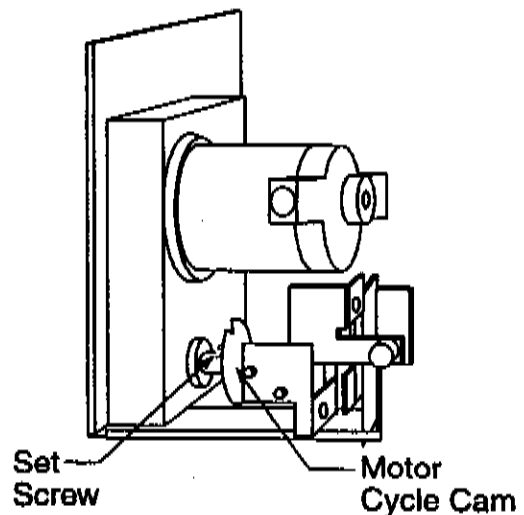
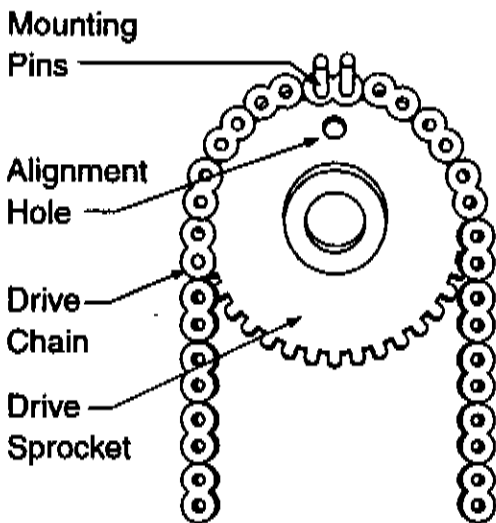

Adjust Drive Chain Tension

In order for the 550's drive mechanism to function properly, it is necessary to ensure that the drive chain be kept tight. As a result of normal use, it may be necessary to adjust the drive chain tension. Follow the directions below.

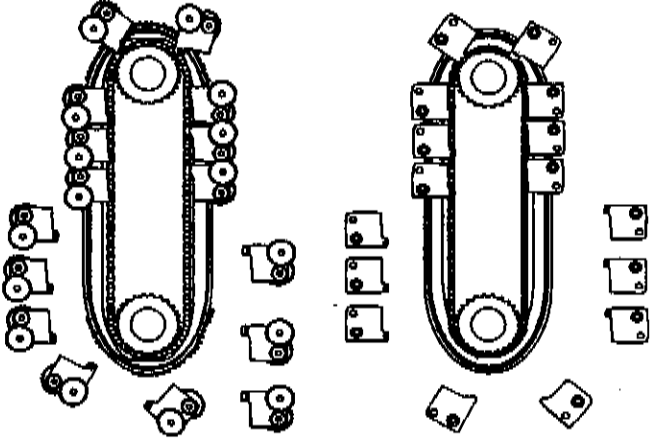
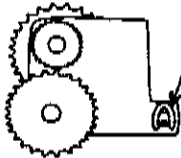
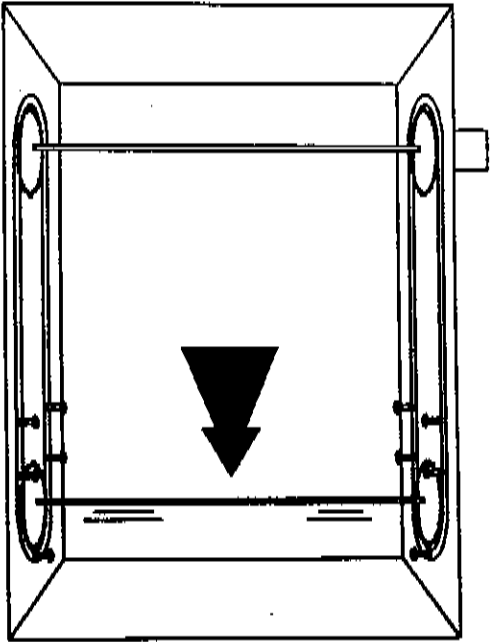
<p>1 Remove the shelves from the machine. Follow the directions on figure 5-1.</p>	<p>3 Remove the carrier assemblies from the lower portion of the carrier tracks as shown.</p> 
<p>2</p>  <p>Remove the retaining clips from the lower carrier assemblies. (See right)</p>	<p>4 Loosen the screws securing the lower carrier tracks.</p> <p>5 Push the lower drive shaft toward the cabinet base. Use equal pressure across the shaft so that it is adjusted equally on the right and left sides.</p> <p>6 Tighten the screws.</p> <p>7 Attach carriers to the drive chain. Ensure that the timing marks on the alignment gears are properly aligned.</p> <p>8 Install the shelves.</p> 

Replacing Solenoids

Occasionally it may become necessary to replace the solenoids that operate the baffles. Replacing solenoids is a simple procedure. Just follow the steps listed below.

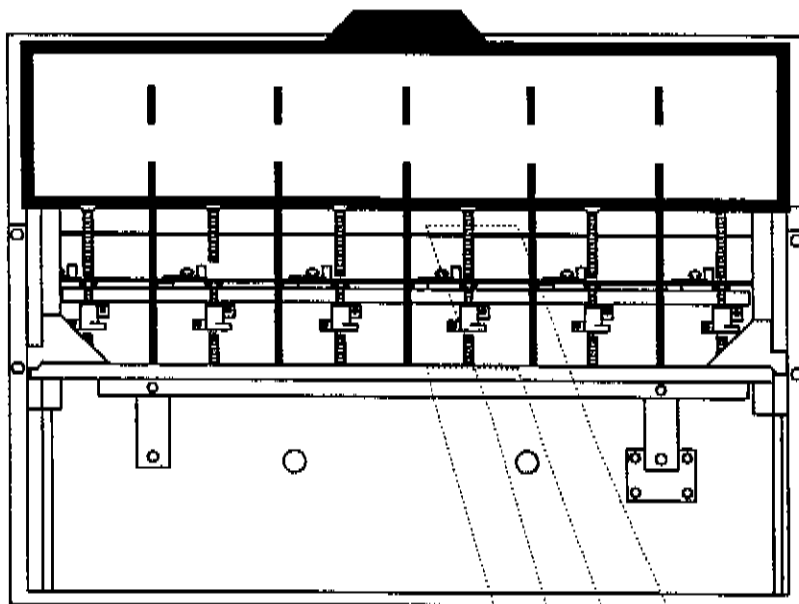

1 Unhook the spring from the top and bottom of the carriage assembly.

2 Remove the screws securing the solenoid bracket.

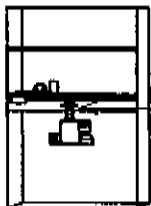

4 Pull the plunger and spring assembly down so that it is free of the latch assembly.

5 Remove the solenoid.

3 Remove the connection wire from the solenoid.

NOTE

The spring and plunger assembly is not a part of the solenoid, and will need to be re-installed with the new solenoid. **DON'T LOSE IT.**

Remove Baffle Assembly

To remove the Baffle Assembly follow the directions below.

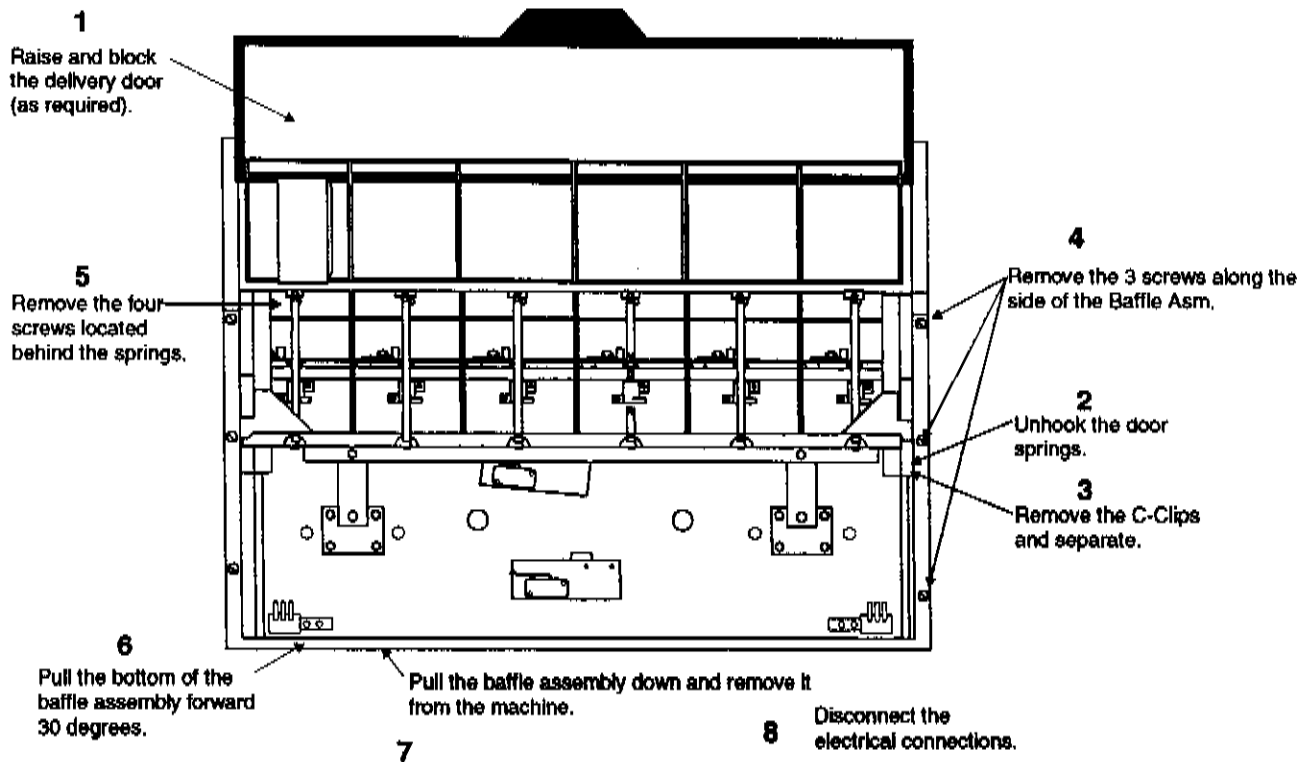

NOTE: Ensure that the screws indicated in step 5 are removed.

Adjustments

I. Adjust Baffle Height

To adjust the baffle height, it is necessary to properly position the CARRIAGE UP and CARRIAGE DOWN limit switch assemblies. The limit switches are engaged by the carriage assembly when opening and closing the baffles. When the limit switch is engaged the controller recognizes that the carriage assembly is in the proper position and stops its movement. The limit switches should be adjusted so that they are engaged at the top and bottom of the carriage assembly's cycle.

II. Belt Tension

The carriage assembly is driven by a drive belt located behind the baffle assembly. The drive belt should always be kept tight to avoid slippage. To adjust the belt tension, loosen the screws on the carriage arm and slide the assembly to the right.

III. Carriage Position

To adjust the right and left position of the carriage, loosen the screws indicated in the illustration below, and make the necessary adjustments.

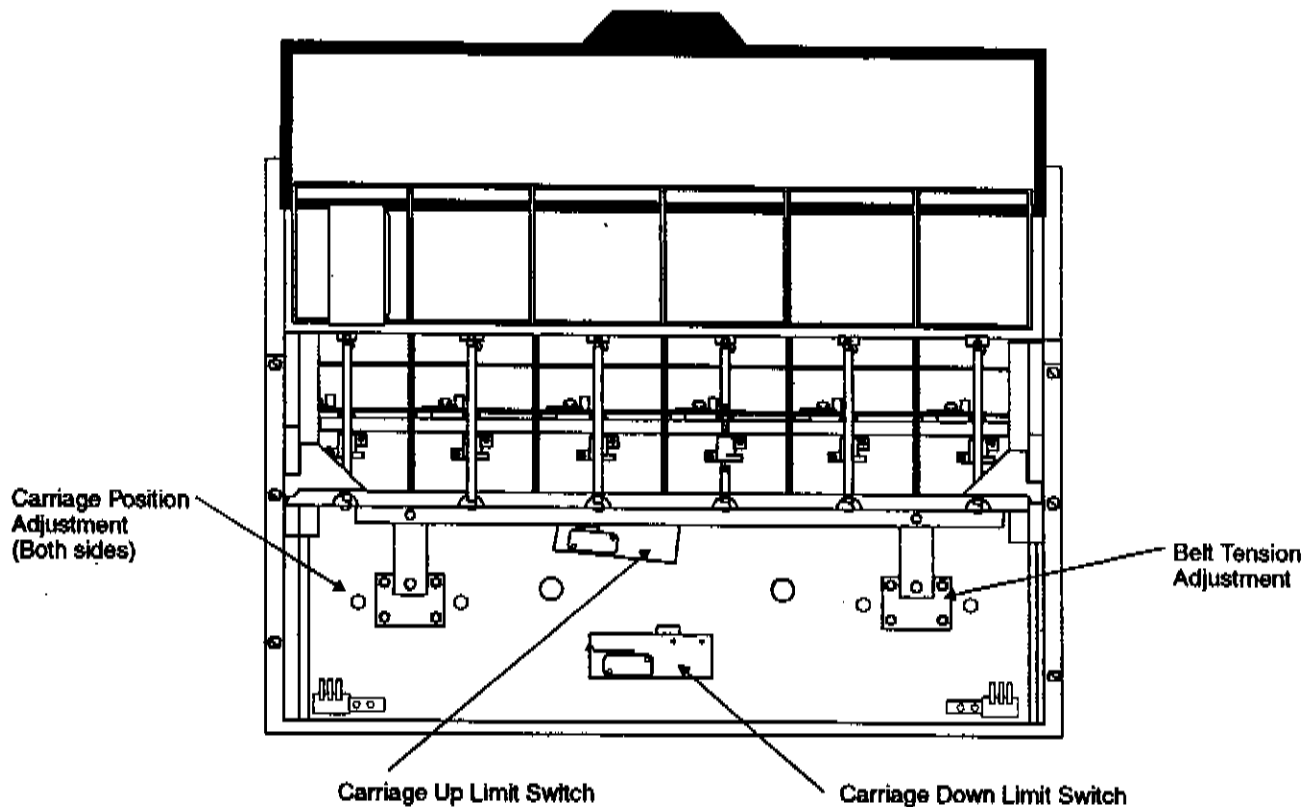

Change the fluorescent light located in the door

Refer to the illustration below.

- 1) Remove the 3 screws securing the lamp access panel.
- 2) Remove the lamp access panel.
- 3) Change the fluorescent lamp.

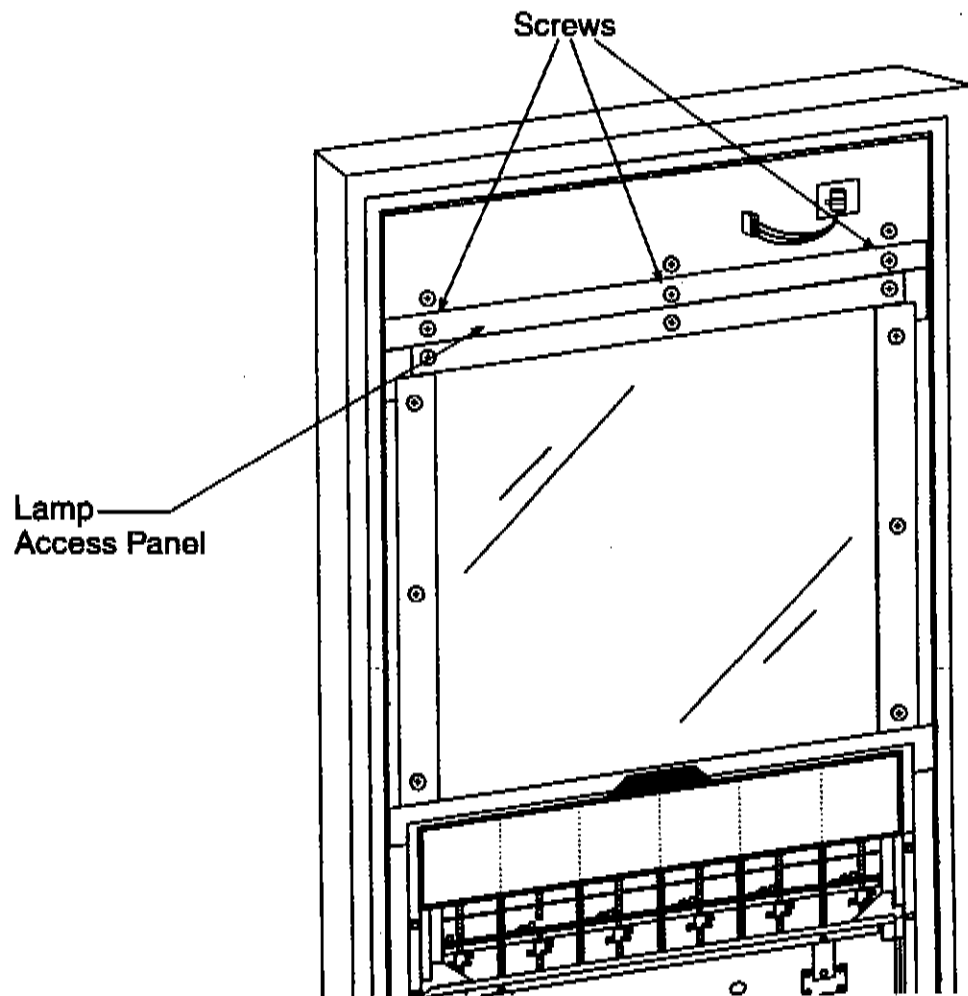

Parts Catalog

Table of Contents

Figure	Description	Page
1	Cabinet Assembly	6-4
1A	Drive Assembly	6-6
1B	Drive Motor	6-8
1C	Carrier Assembly - Left	6-10
1D	Carrier Assembly - Right	6-11
2	Power Switch Assembly	6-12
3	Main Door Exterior	6-14
3A	Delivery Door Assembly	6-16
3B	Selector Panel Components	6-18
3C	Shelf Assembly	6-19
3D	PCB Assembly - Horizontal Display	6-20
4	Main Door Interior	6-22
5	Baffle Plate Assembly - Front	6-24
5A	Baffle Plate Assembly - Back	6-26
5B	Baffle Release Components	6-27
6	Sliding Panel Assembly - Side View	6-28
6A	Sliding Panel Assembly - Front View	6-30
7	Refrigeration Unit	6-33
8	Universal Control Board	6-34
9	Power Supply Circuit Board	37
10	Hardware List	40
11	Harness List	41

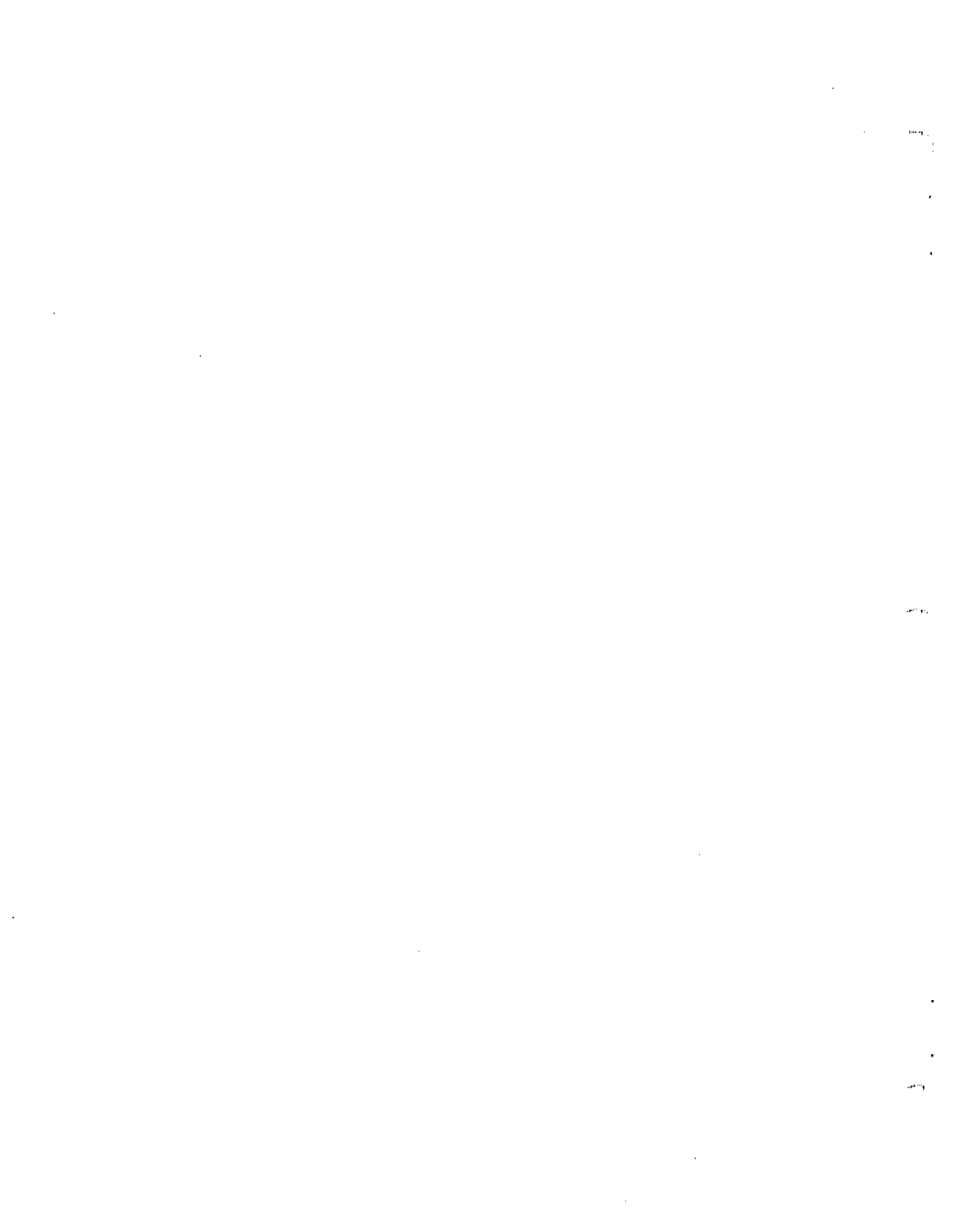

Section 6

Parts Catalog

INTRODUCTION

This parts catalog contains a list of replacement parts for the vendor that are available from Rowe Distributors. Each list contains an index of the part, Rowe Part Number, a description of the part and the quantity required for the assembly. Separate parts of riveted or welded assemblies are not available from the factory as replacement parts.

Parts Callout

Each table in the Parts Callout contains four columns. Following is a description of each column in the order of appearance on the Parts Callout tables.

Fig. and Index No.

This column lists the figure number as the first entry on each page. An index number keys the part to the figure.

ROWE Part No.

This column lists the part number of the item that should be used for ordering.

Description

This column gives the name of the assembly or part.

Qty. per Asm..

This column contains the exact quantity of the item required for its next higher assembly.

ORDERING REPLACEMENT PARTS

All parts must be ordered from an authorized Rowe Distributor. Parts orders are often delayed because of inadequate or incomplete ordering information. Be sure to include all required information which consists of:

1. Rowe Part Number and Description exactly as it appears in the Parts Catalog. State color if applicable.
2. Quantity being ordered.
3. Model and Serial Number of vendor for which the part is required. This is necessary because of manufacturing changes.
4. Complete shipping address including ZIP code.
5. Specify shipping instructions. It is advisable to indicate an alternate shipping method because packages may exceed the size and weight limits established by the shipping agency of your choice.

**FIGURE
1**

Cabinet Assembly

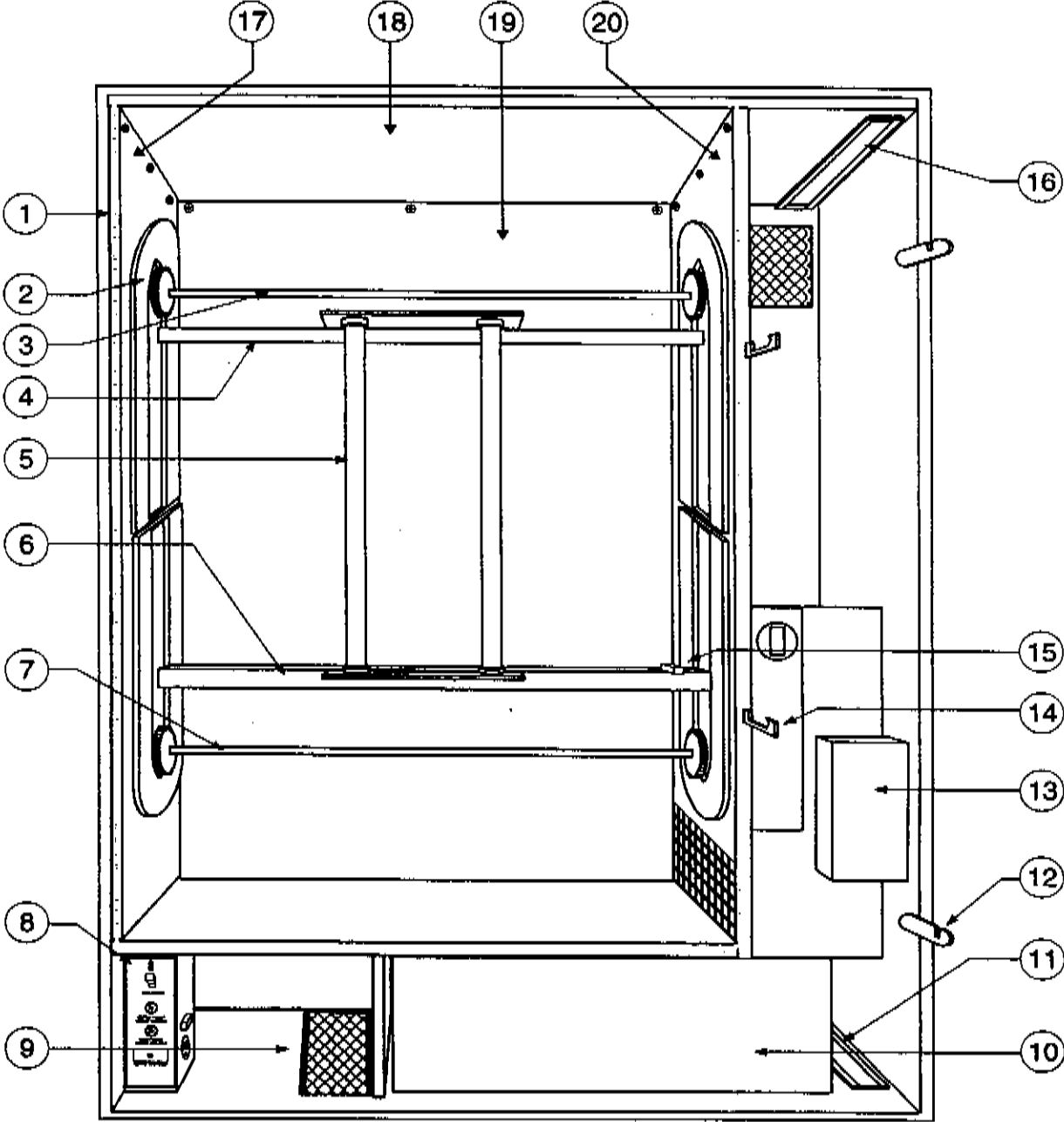
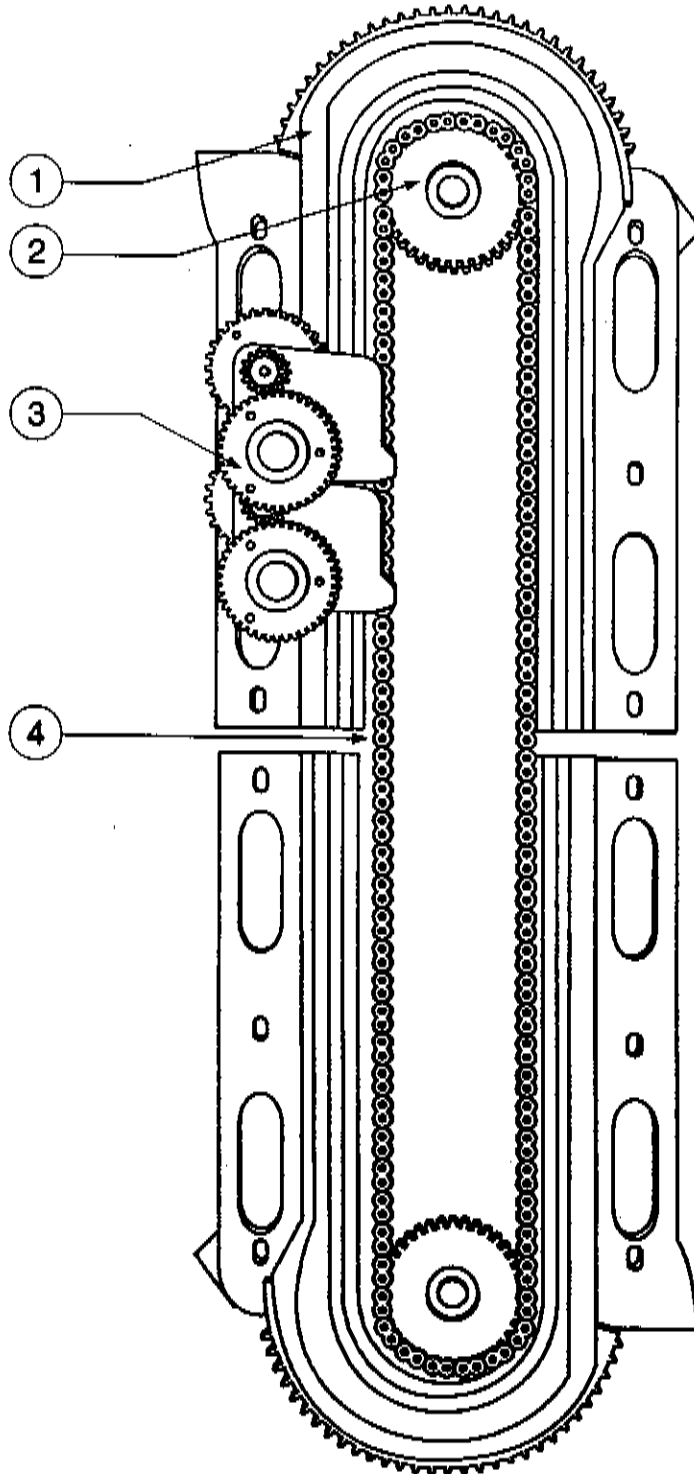

**FIGURE
I**

Figure & Index Number	Rowe Part Number	Description	Quantity Per Assembly
	550-1900	Cabinet Assembly	REF
1	866-68001	Rubber Channel	1
2	Drive Assembly (See Figure 1A)		REF
3	550-100	Drive Shaft - Upper	1
	915-16	Pin - Groove	1
4	550-909	Bracket - Lamp	1
5	917-116	Lamp - Fluorescent	2
6	550-907	Duct - Air, Top	1
	550-908	Duct - Air, Top	1
7	550-113	Shaft - Drive, Lower	1
8	550-1858	Switch Panel Assembly - Domestic (See Fig 2 for Detail)	1
9	550-1906	Intake Screen W/A	1
10	550-1200	Refrigeration Unit	1
11	550-1305	Slide - Extension, Panel	3
12	493-325	Hook - Door Lock	2
13	593-1904	Coin Box W/A	1
	550-1905	Bracket - Cash Box Retainer	1
14	550-914	Hook - Door	1
15	548-1816	Switch Assembly - Zero Position	1
	448-2830	Switch - Zero Position	1
	548-452	Housing - Zero Position Switch	1
	548-453	Pad - Zero Position	1
16	550-1305	Slide - Extension, Top	3
17	550-323	Liner - Cabinet, Left Side	1
18	550-326	Liner - Cabinet, Top & Bottom	2
19	550-325	Liner - Cabinet, Back	1
20	550-324	Liner - Cabinet, Right Side	1

**FIGURE
1A**

Drive Assembly

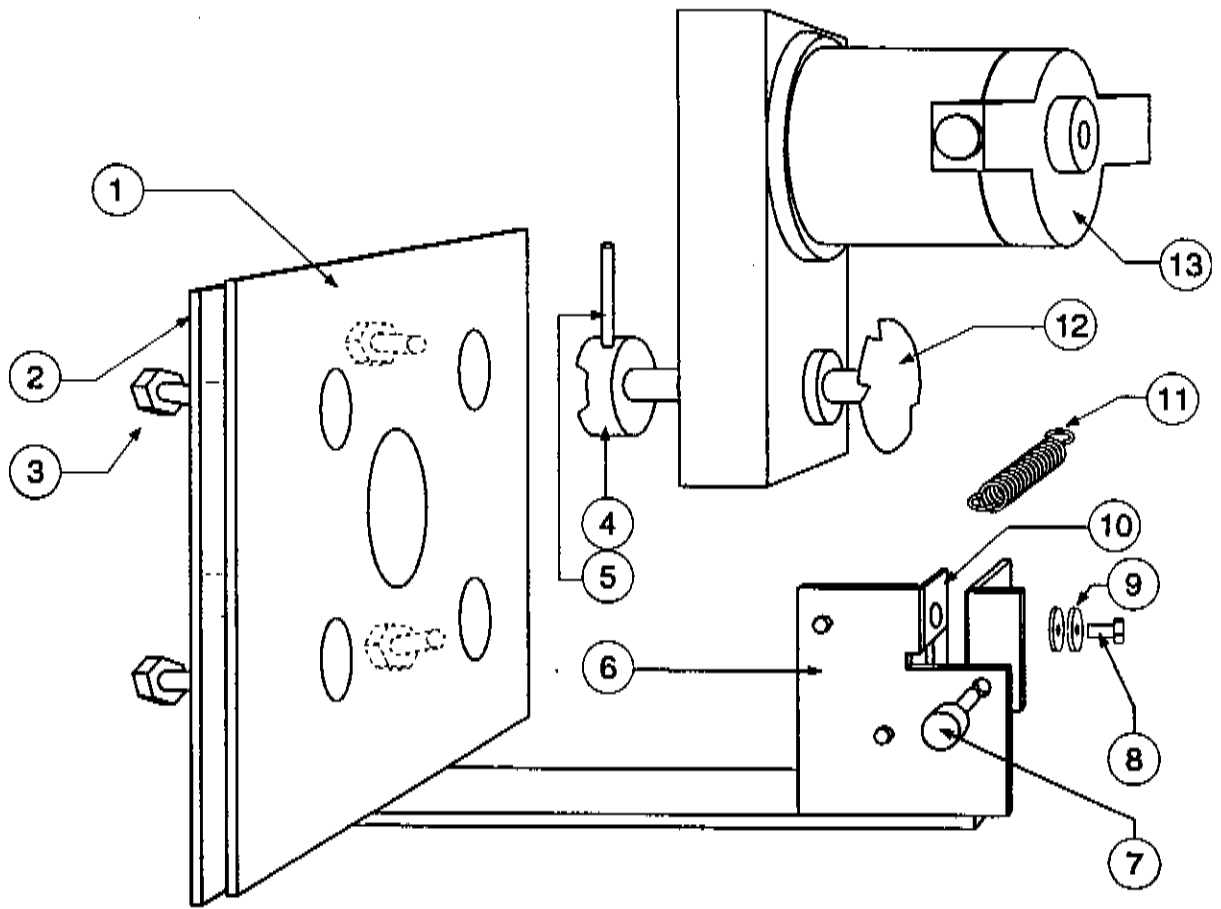

**FIGURE
1A**

Figure & Index Number	Rowe Part Number	Description	Quantity Per Assembly
1	550-110	Track - Gear	2 per side
2	550-102	Sprocket - 30 tooth	4
	550-905	Key - Sprocket	3
3	550-1000	Carrier Assembly - Left (See Fig 1C for Detail)	16
	550-1001	Carrier Assembly - Right (See Fig 1D for Detail)	16
4	550-1002	Chain Assembly	1

**FIGURE
1B**

Drive Motor



**FIGURE
1B**

Figure & Index Number	Rowe Part Number	Description	Quantity Per Assembly
	550-1810	Drive Motor & Optical Sensor Assembly	REF
1	550-811	Plate Motor Mounting	1
2	550-805	Seal Drive	1
3	921-407	Screw	4
4	550-904	Coupling - Drive	1
5	915-18	Groove Pin	1
6	550-1849	PCB - Optical Sensor	1
	934-307	Screw	2
7	921-605	Torque Knob	1
8	934-307	Screw	2
9	485-26	Bushing - Pivot Unlatch	1
	950-386	Washer	1
10	550-814	Bracket - Optical Sensor, Adjustable	1
11	485-494	Spring	1
12	550-1864	Optical Cycle Cam	1
	947-26	Set Screw	1
13	550-1811	Motor - 90V	1

**FIGURE
1C**

Carrier Assembly - Left

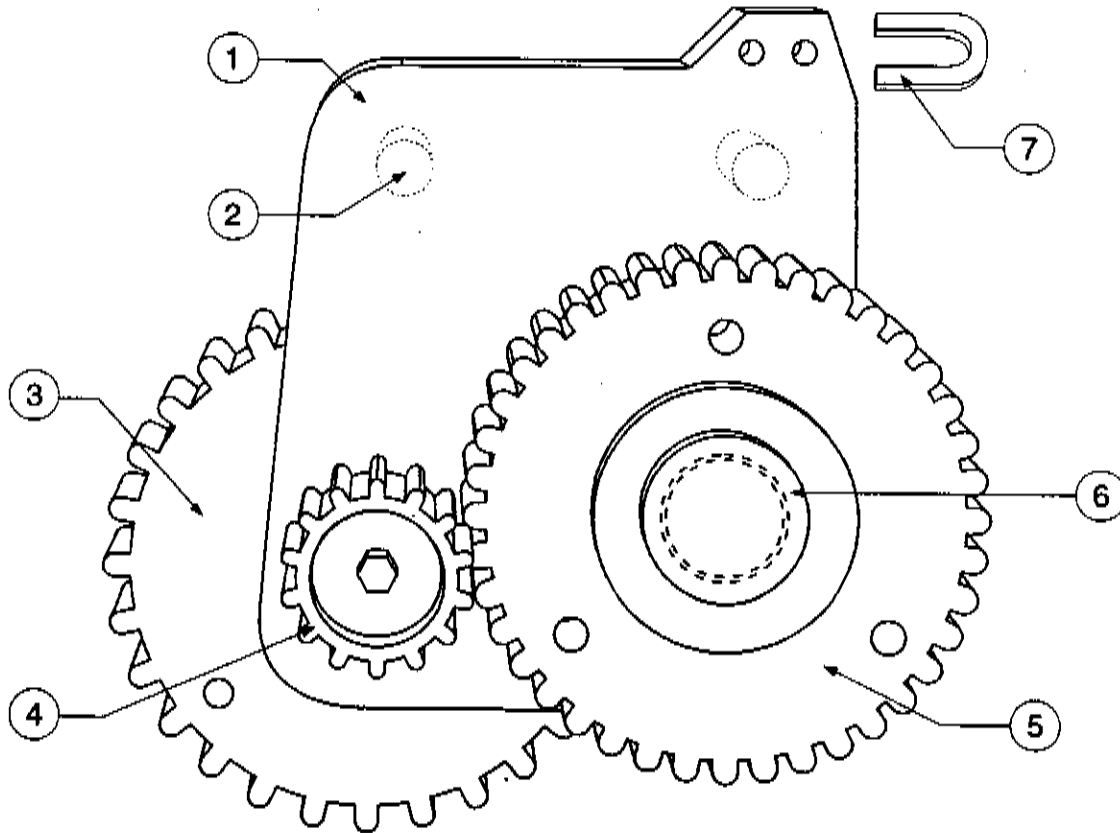

Figure & Index Number	Rowe Part Number	Description	Quantity Per Assembly
	550-1000	Carrier Assembly - L/H	REF
1	550-106	Carrier Shelf	1
2	550-108	Roller - Shelf Carrier (on back)	2
	941-27	Speed Nut	1
3	550-107	Gear - Idler, Large	1
4	550-104	Gear - Idler, Small	1
5	550-105	Hub - Gear Shelf, L/H	1
6	550-109	Retainer - Shelf Hub	1
7	550-114	Clip	1

**FIGURE
1D**

Carrier Assembly - Right

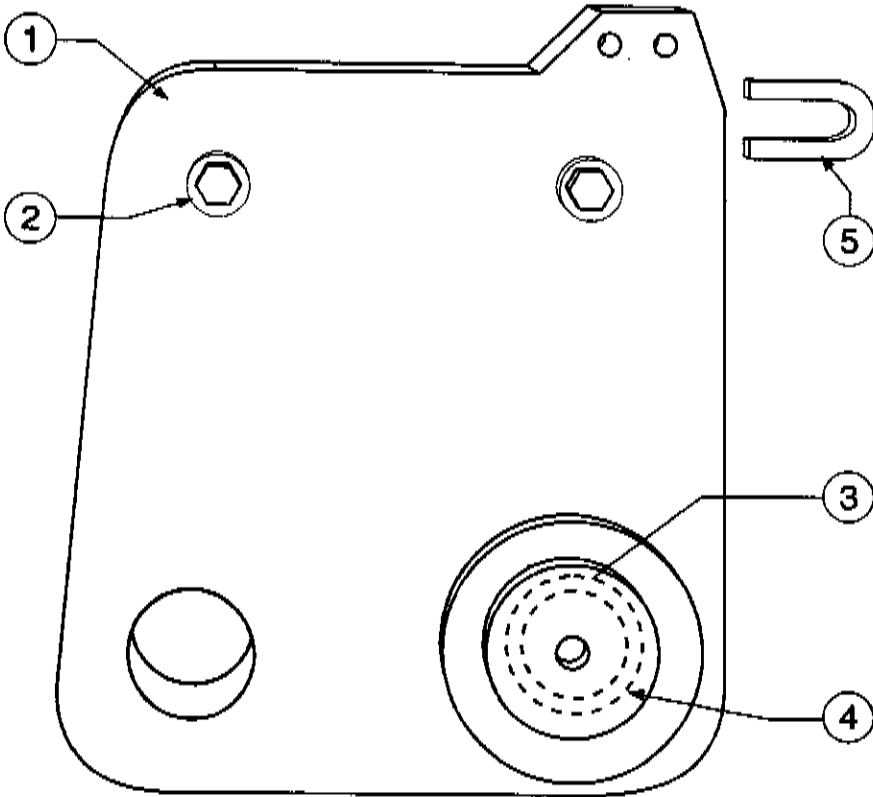
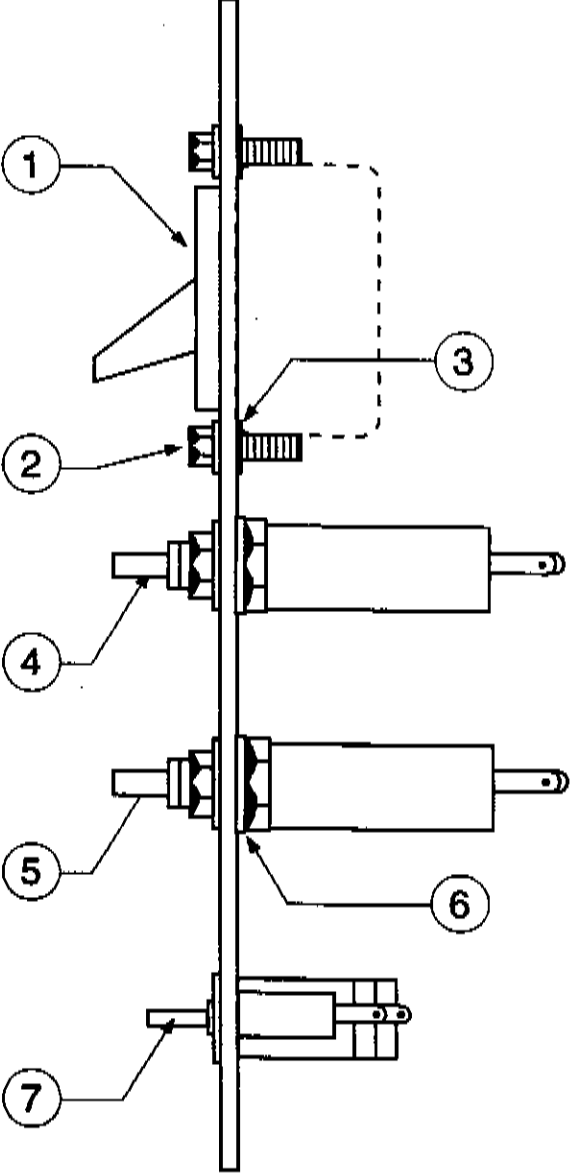
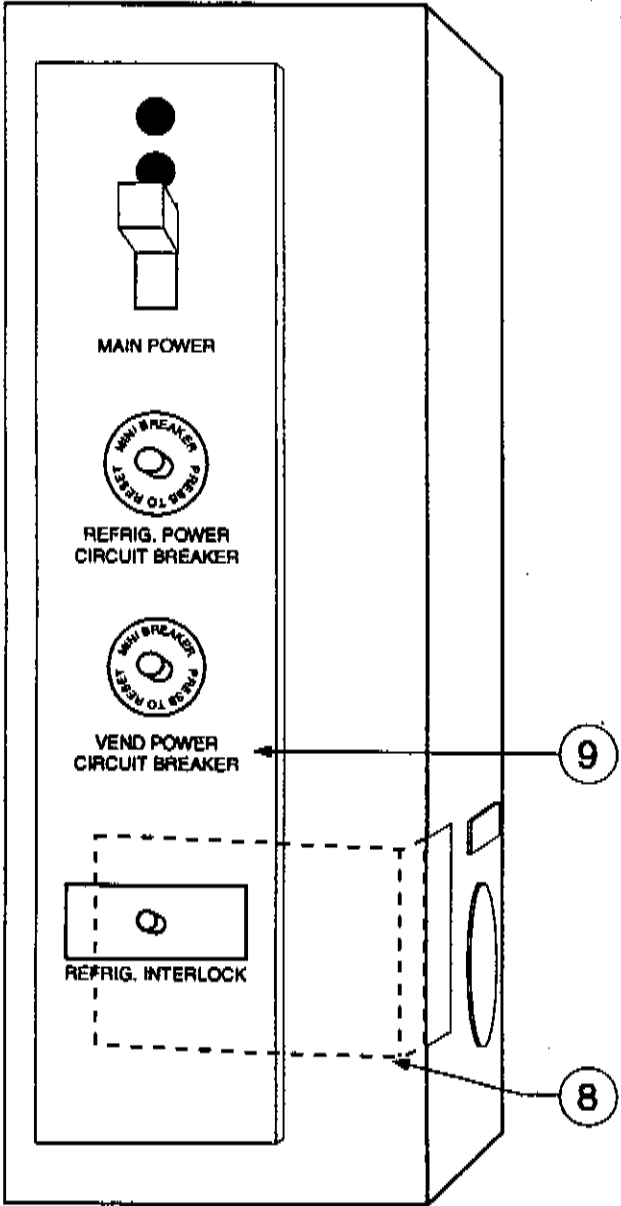

Figure & Index Number	Rowe Part Number	Description	Quantity Per Assembly
	550-1001	Carrier Assembly - R/H	REF
1	550-106	Carrier - Shelf	1
2	550-103	Hub - Gear Shelf, R/H	1
3	550-109	Retainer - Shelf Hub (on back)	1
4	550-108	Roller - Shelf Carrier (on back)	2
	941-27	Speed Nut	2
5	550-114	Clip	1

FIGURE
2

Power Switch Assembly

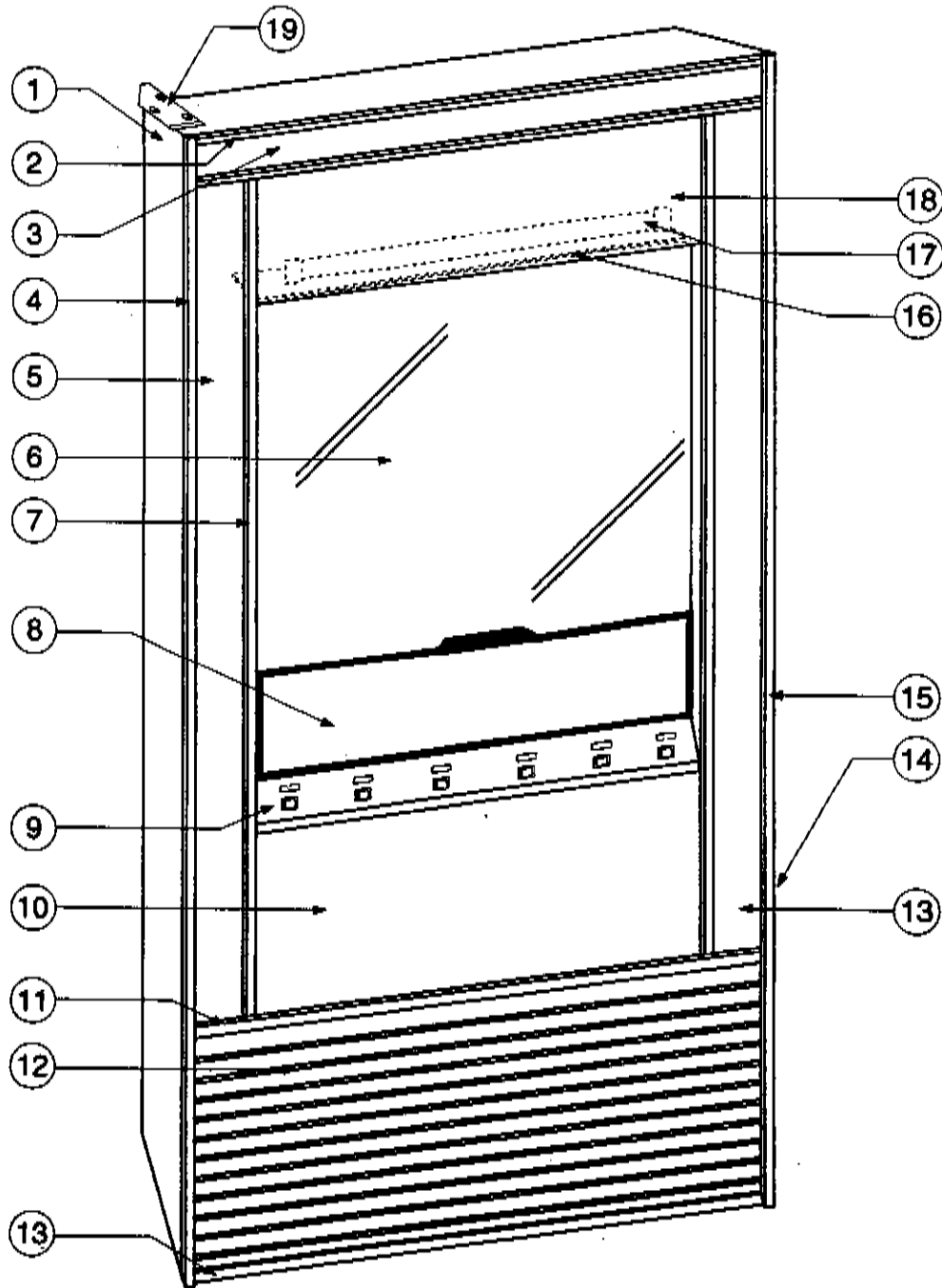

**FIGURE
2**

Figure & Index Number	Rowe Part Number	Description	Quantity Per Assembly
	550-1858	Switch Panel Assembly	REF
1	301-1711	Switch - Toggle	1
2	921-287	Screw	2
3	950-349	Lockwasher	2
4	912-47	Fuse - 15 Amp., Circuit Protection	1
5	912-50	Fuse - 7 Amp., Circuit Protection	1
6	950-112	Washer	2
7	448-12848	Switch - Line Interrupt	1
8	448-2819	Spring - Refrigeration Actuator	1
9	550-1805	Switch Panel Silk Screen Assembly	1

**FIGURE
3**

Main Door Assembly - Exterior



**FIGURE
3**

Figure & Index Number	Rowe Part Number	Description	Quantity Per Assembly
	550-1400	Main Door Assembly	REF
1	550-1401	Main Door W/A	1
2	983-40	Trim - Header (Clear)	1
	983-41	Trim - Header (Black)	1
3	985-45-*	Insert - Header	1
4	983-101	Trim - Door (Clear)	1
	983-102	Trim - Door (Black)	1
	983-325	Trim Retainer	2
	935-154	Screw	4
5	985-69-*	Overlay - Vertical L.H.	1
6	550-1410	Heated Glass - 24V	1
7	983-249	Trim - Door (Black)	2
	983-248	Trim - Door (Clear)	2
	983-354	Trim Retainer	2
	935-154	Screw	?
8	550-1405	Delivery Door Assembly (Refer to Figure 2A)	1
9	550-1817	Horizontal Display (Refer to Figure 2B)	1
10	985-44-*	Overlay - Center, Door	1
11	983-244	Trim - Door, Black	1
	983-245	Trim - Door (Clear)	1
	983-346	Trim Retainer	1
	935-154	Screw	4
12	505-1402	Overlay - Door Bottom (Genesis - Black & Silver)	1
13	550-473-309	Trim - Door Bottom (Black Textured)	1
14	550-1413	Door Latch Rivet Assembly	1
15	983-1000	Trim - Door, Vertical (Black)	1
	983-1001	Trim - Door, Vertical (Clear)	1
16	550-486	Shield - Light	1
17	917-116	Lamp	1
18	550-469-*	Overlay - Door Top	1

* Overlay and trim panels are available in several finish colors, indicated by the last dash number of the part number. When ordering this part, it is necessary to indicate the desired color. For example, figure #10 above, P/N 985-40-*, Insert - Sliding Panel, can be ordered in black, P/N 985-40-9, or Roweswood 985-40-1. Refer to the chart below for finish color numbers.

FINISH COLORS

- 1 Roweswood	- 12 Port-Au-Prince
- 2 Presidential Walnut	- 13 Stainless Steel Mylar
- 3 Regency Walnut	- 15 Stainless Steel Mylar
- 7 Shadow Silver	- 29 Teak
- 9 Black	- 32 Terra Cotta
- 10 Golden Leather	- 69 Chamois
- 11 Brushed Bronze	- 79 Charcoal Brown

**FIGURE
3A**

Delivery Door Assembly

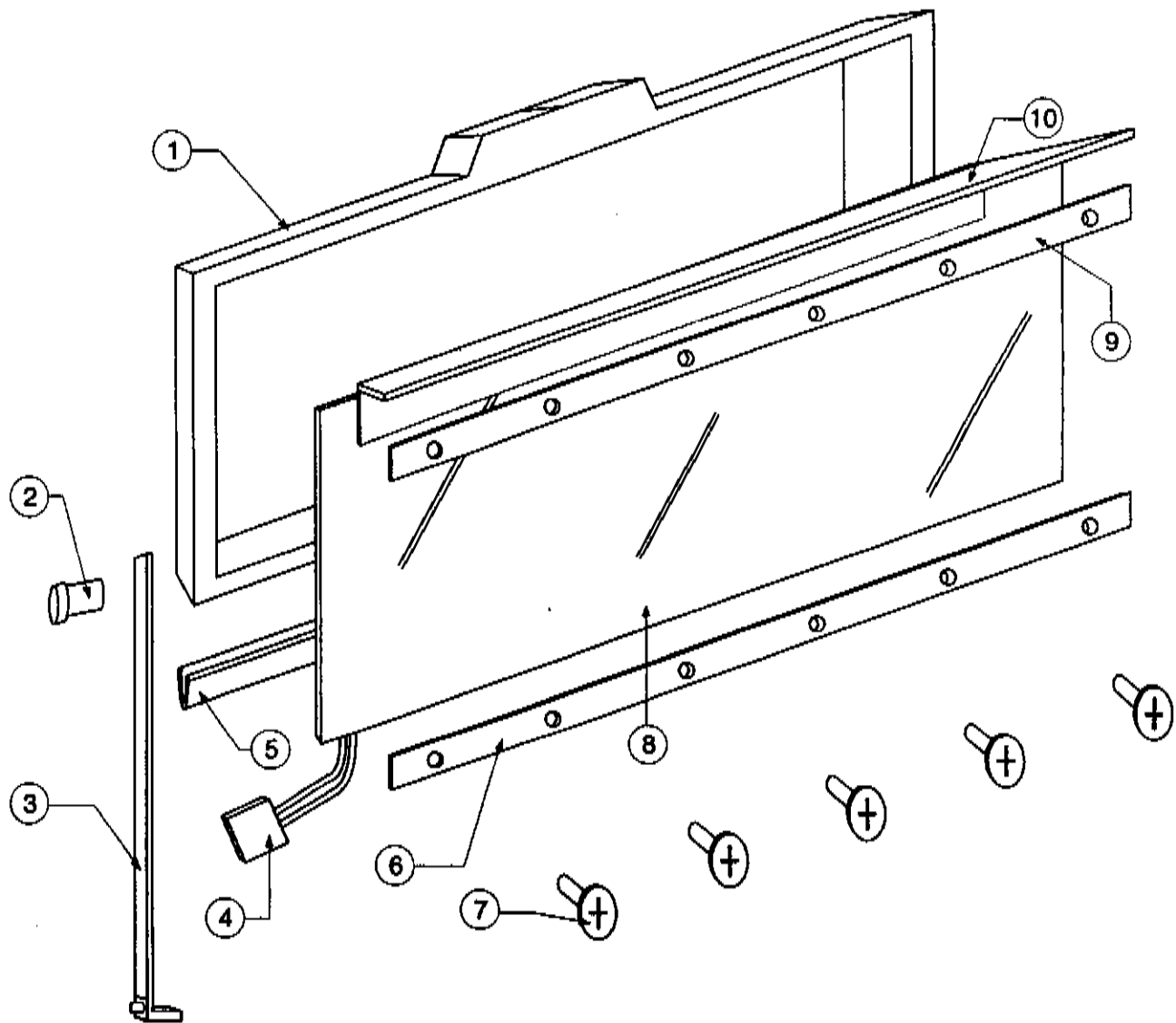

**FIGURE
3A**

Figure & Index Number	Rowe Part Number	Description	Quantity Per Assembly
	550-1405	Delivery Door Assembly	REF
1	550-467	Frame - Delivery Door	1
2	550-431	Guide - Glass Wire	2
	933-107	Retaining Ring	2
3	550-1415	Link Assembly - Delivery Door	1
4	979-194	Plug - 2 Contacts	1
5	550-424	Seal - Delivery Door	1
6	550-430	Strip - Delivery Door, Top	1
7	934-486	Screw	12
8	550-1411	Heated Insulated Glass	1
9	550-429	Strip - Delivery Door, Top	1
10	550-425	Gasket - Delivery Door, Top	1

**FIGURE
3B**

Selector Panel Components

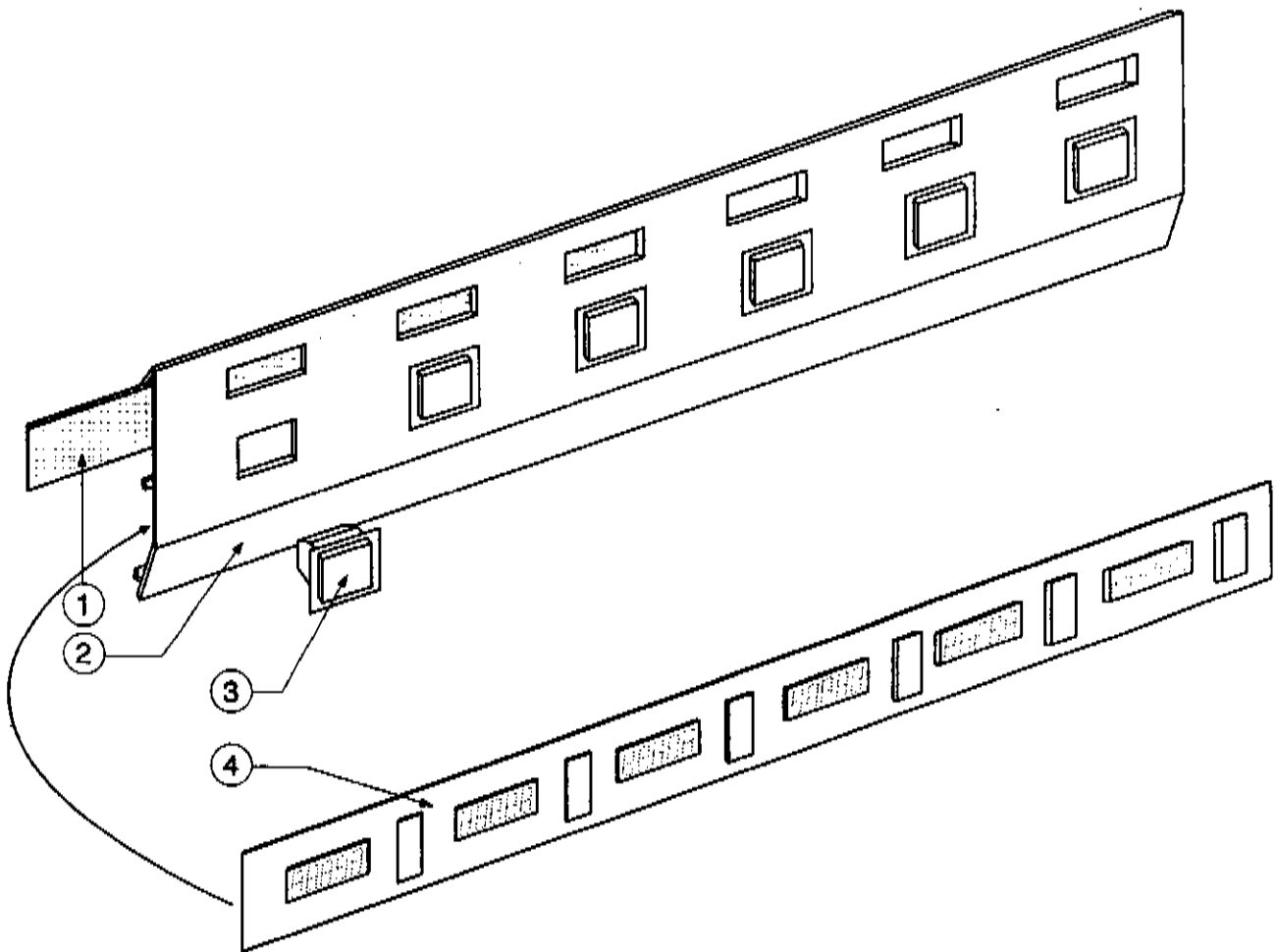

Figure & Index Number	Rowe Part Number	Description	Quantity Per Assembly
1	550-555	Lens - Horizontal Display	1
2	550-410	Panel - Selector Display	1
3	550-1813	Pushbutton Switch Assembly - Door	6
4	550-1817	Circuit Board Assembly - Horizontal Display	1

**FIGURE
3C**

Shelf Assembly

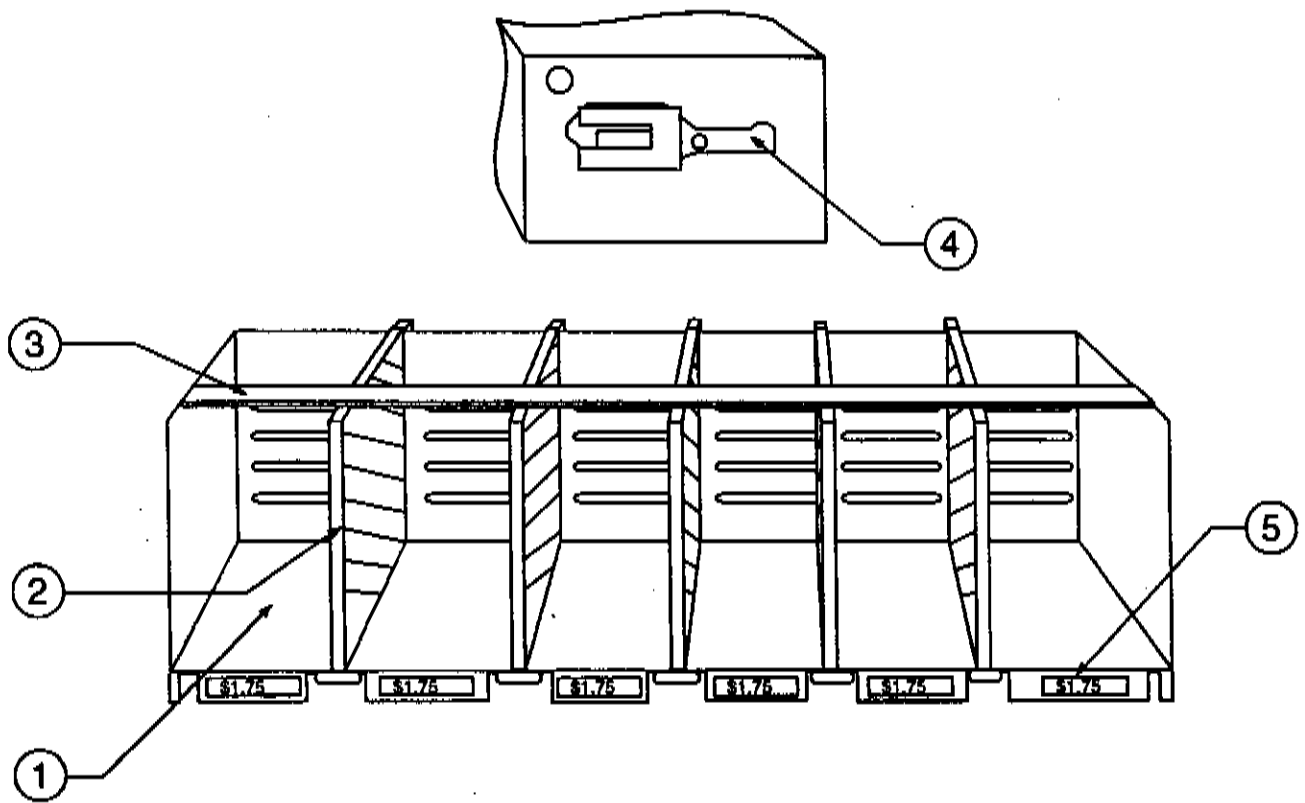
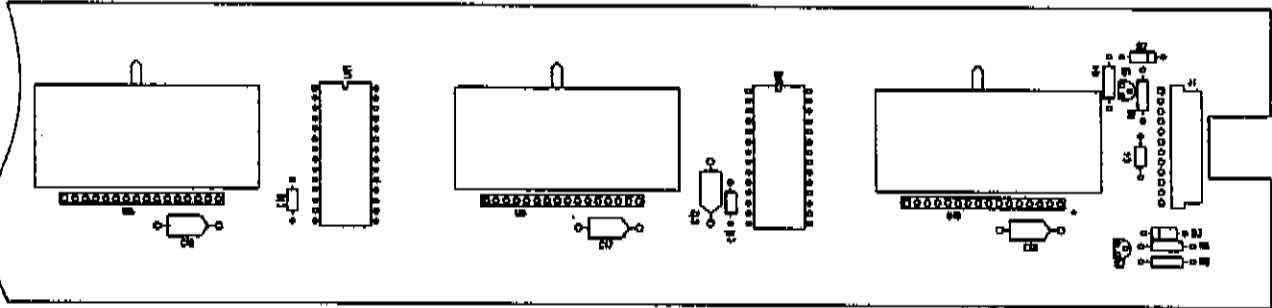
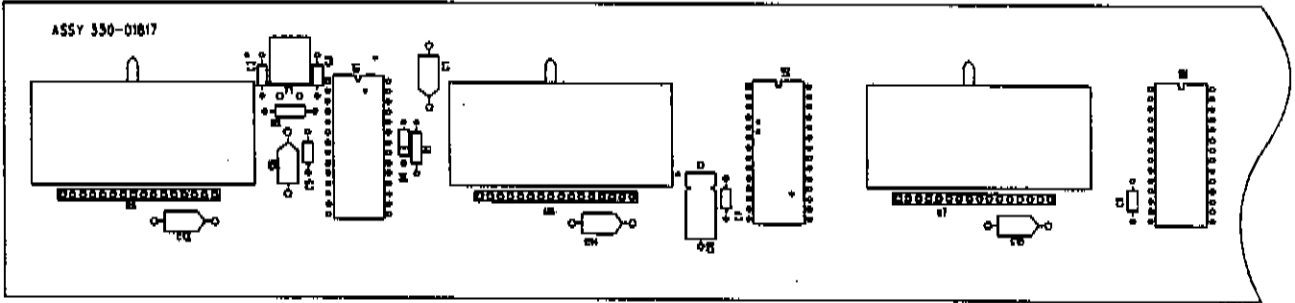

Figure & Index Number	Rowe Part Number	Description	Quantity Per Assembly
1	550-1600	Shelf Assembly	REF
2	550-607	Divider	2
3	550-610	Lockbar - Dividers	1
4	550-606	Latch	1
	905-51	Hitch Pin - 3/16"	2
5	550-1907	Price Card Assortment (1 set per machine)	1

**FIGURE
3D**

PCB Assembly - Horizontal Display



**FIGURE
3D**

PCB Assembly - Horizontal Display

REFERENCE	DESCRIPTION	PART NUMBER
C2, C3	Capacitor - 10PF 50V 10%	70028701
C4, C5, C7, C9, C10, C11	Capacitor - .1 μ F 50V 10%	70028649
Y1	Xtal - 10 Mhz	70702401
D1, D2, D3	Diode 75V .75 Amp	70035012
U2, U3, U11, U12	IC - Display Driver	70702501
U1	IC - 8 Bit Microprocessor w/ UART	70702601
U5, U6, U7, U8, U9, U10	Display - 5 Digit Fluorescent	70702701
R3, R4, R5, R6	Resistor - 4.7K 1/4W 5%	79901472
R1	Resistor - 10K 1/4W 5%	79901103
R2	Resistor - 510K 1/4W 5%	79901514
Q1, Q2	Transistor - NPN Bipolar 40V .2 Amp	225A000-2N3904
C1, C6, C12, C13, C14, C15, C16, C17, C18	Capacitor - 15 μ F 15V 10%	70025302
C8	Capacitor - 22 μ F 50V 20%	70703001
J1	Connector - HDR 12 Position .1"	70087112

**FIGURE
4**

Main Door Assembly - Interior

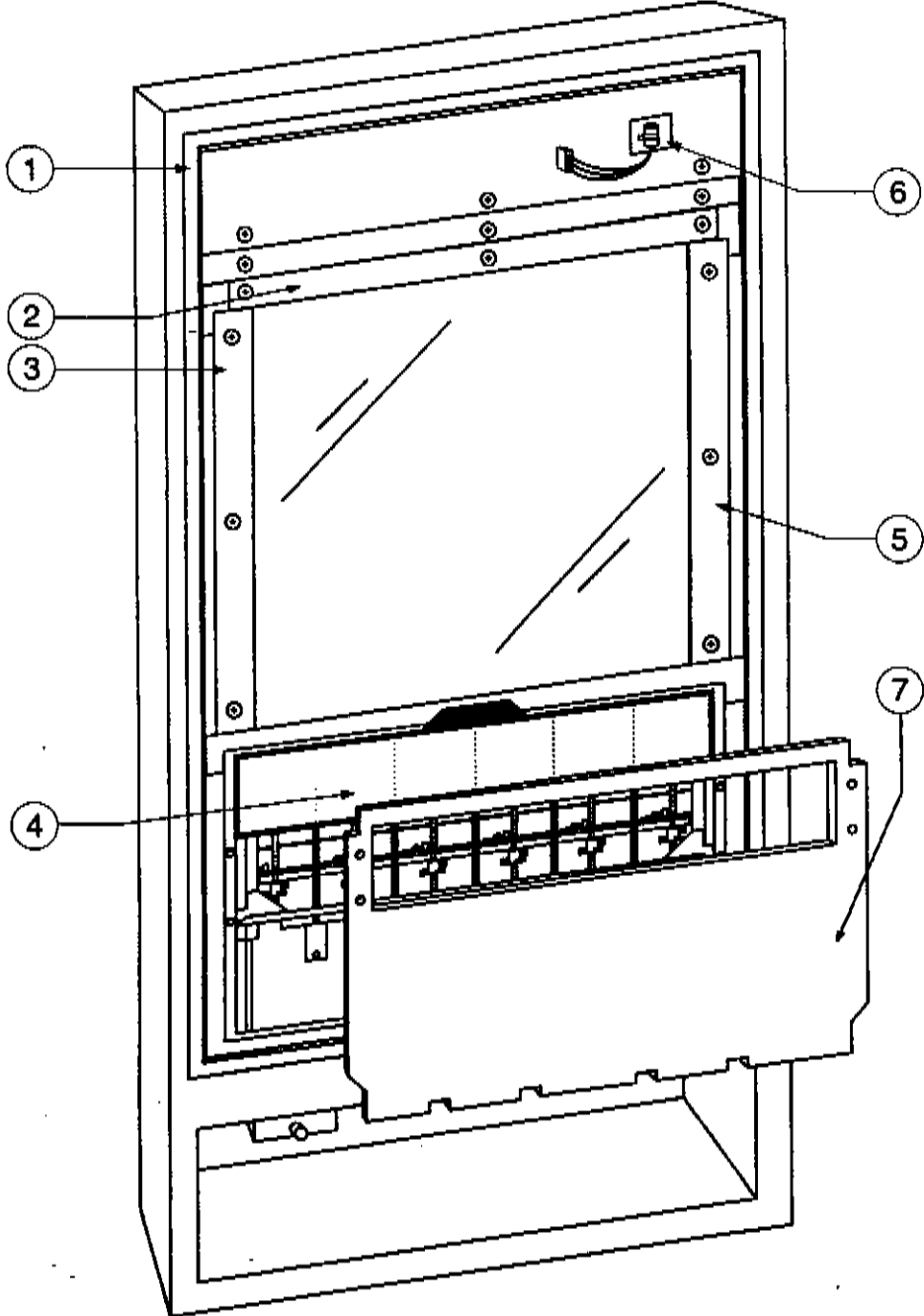
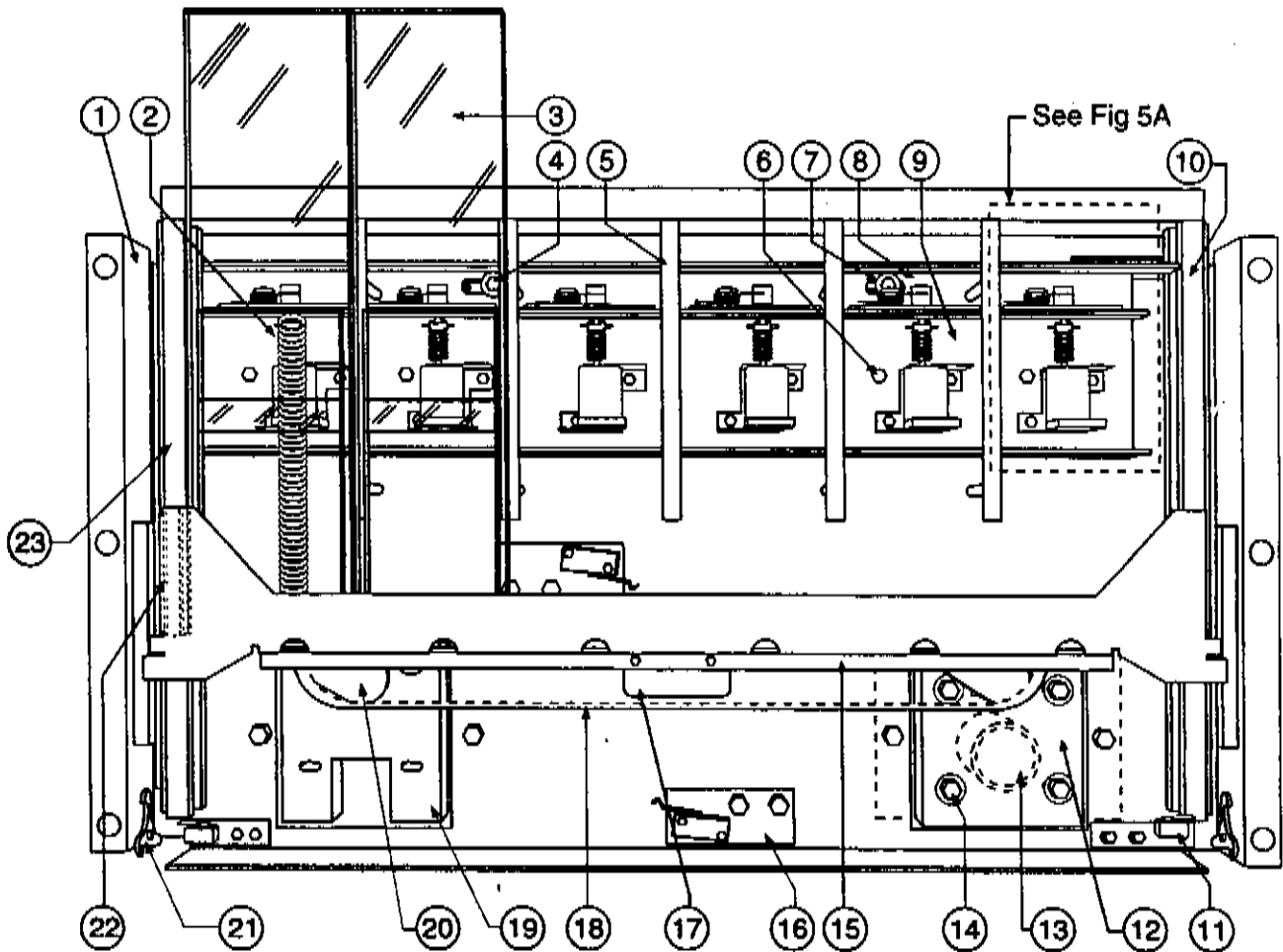

**FIGURE
4**

Figure & Index Number	Rowe Part Number	Description	Quantity Per Assembly
	550-1400	Main Door Assembly	REF
1	550-415	Gasket - Door	1
2	550-1430	Lamp Access Panel	1
3	550-1421	Glass Side Support - Left	1
4	550-1414	Baffle Plate Assembly (See Figure 5)	1
5	550-1422	Glass Side Support - Right	1
6	548-1818	Probe - Temperature	1
	548-506	Insulation - Temperature Sensor	1
7	550-1501	Security Cover W/A	1

**FIGURE
5**

Baffle Plate Assembly (Front)



**FIGURE
5**

Figure & Index Number	Rowe Part Number	Description	Quantity Per Assembly
	550-1414	Baffle Plate Assembly	REF
1	550-1420	Baffle Plate & Guide W/A	1
2	550-573	Spring - Door, Delivery Box	6
3	550-406	Baffle - Product	6
4	934-307	Screw	2
5	550-408	Guide - Baffle Center	5
	934-447	Screw	10
6	934-307	Screw	4
7	485-26	Bushing - Pivot Unlatch	2
8	550-559	Bar - Reset	1
9	550-1427	Bracket W/A - Solenoid Mounting	1
10	550-407	Guide - Baffle - Left Hand	1
	934-447	Screw	3
11	550-442	Bracket - Delivery Door Switch	2
	934-307	Screw	4
	548-1817	Switch - Delivery Door Panel	2
	939-1304	Insulation Sheet	2
	921-626	Screw	4
12	550-447	Hat - Drive Mounting	1
	934-318	Screw	2
13	550-1815	Motor - Crank & Pin Assembly	1
	550-1812	Motor - Baffle	1
	550-1416	Crank - Weld Assembly, Motor	1
	924-64	Nut	2
14	921-217	Screw	4
	950-52	Washer	4
15	550-1419	Carriage - Baffle Weld Assembly	1
16	550-441	Plate Carriage - Motor Switch	2
	934-307	Screw	4
	448-1867	Switch	2
	934-403	Screw	4
17	550-443	Actuator - Switch	1
	934-307	Screw	2
18	550-426	Timing Belt - Carriage Drive	1
19	550-447	Hat - Drive Mounting	1
	934-318	Screw	2
20	550-1417	Crank Weld Assembly - Idler	1
	926-15	Bearing Prod. - Drum	1
	934-485	Screw	3
	550-535	Pulley - Timing Belt	1
21	550-439	Latch - Delivery Door	4
	550-440	Pivot - Delivery Door Lock	2
	933-58	Retaining Ring	2
	333-454	Lockout Spring	2
22	550-419	Guide Carriage	2
	934-21	Screw	4
23	550-409	Guide - Baffle, R.H	1
	934-447	Screw	3

**FIGURE
5A**

Baffle Plate Assembly (Back)

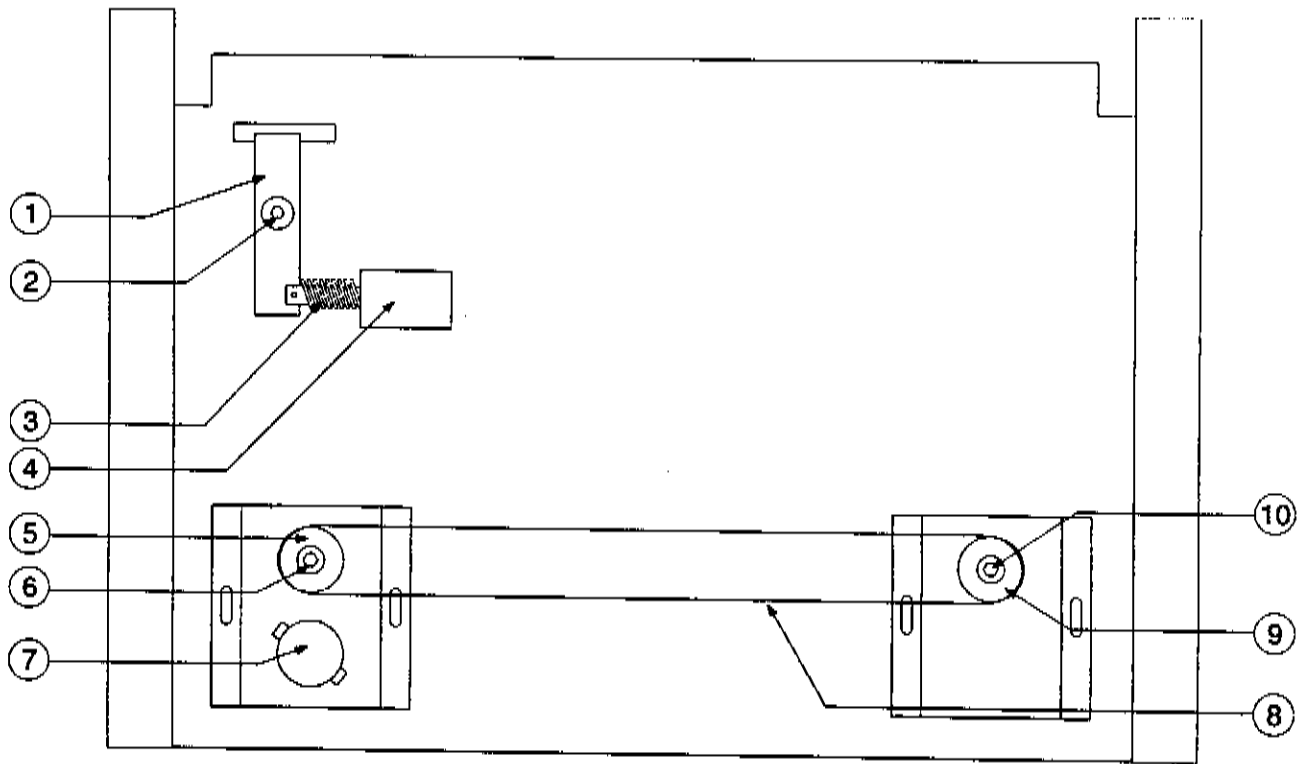

Figure & Index Number	Rowe Part Number	Description	Quantity Per Assembly
1	550-561	Lever - Reset Bar	1
	485-20	Bushing - Pivot Unlatch	1
2	934-307	Screw	1
3	550-1863	Solenoid & Diode Assembly	1
	550-812	Solenoid - Baffle Reset	1
	950-193	Washer	4
	921-217	Screw	4
4	550-562	Spring - Reset Bar	1
5	550-535	Pulley - Timing Belt	1
6	921-217	Screw	1
	950-52	Washer	1
	550-1815	Motor Crank & Pin Assembly	1
7	924-64	Nut	1
	921-217	Screw	4
	950-52	Washer	4
	550-426	Timing Belt - Carriage Belt	1
8	550-426	Timing Belt - Carriage Belt	1
9	550-535	Pulley - Timing Belt	1
10	921-217	Screw	1
	950-52	Washer	1

**FIGURE
5B**

Baffle Release Components

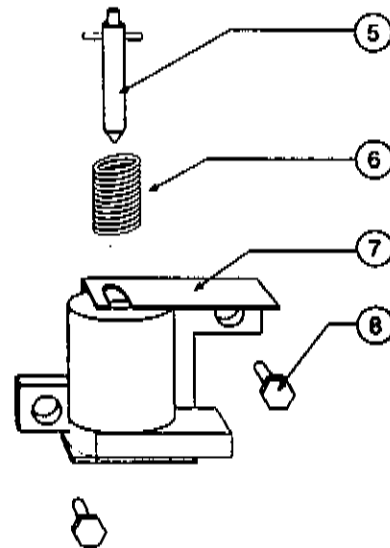
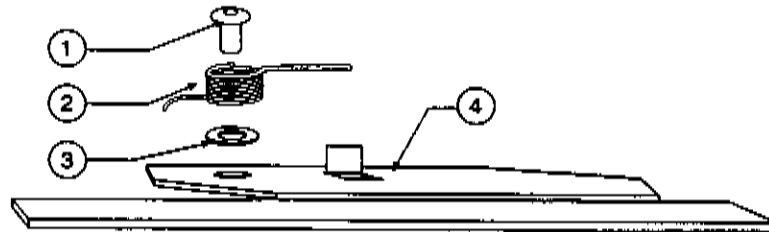
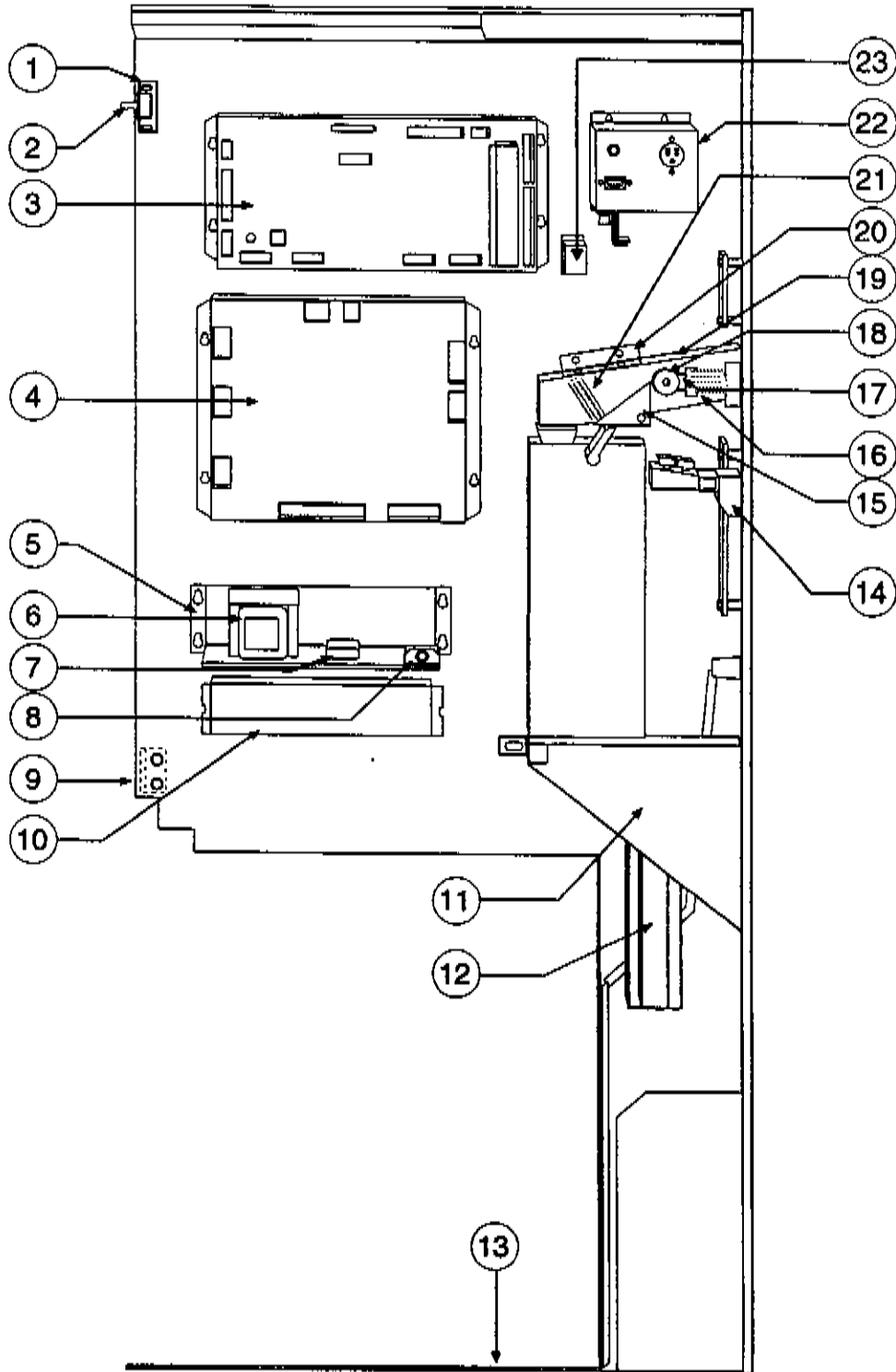

Figure & Index Number	Rowe Part Number	Description	Quantity Per Assembly
1	934-492	Screw	6
2	550-458	Spring - Latch Plate	6
3	550-457	Spacer - Pivot Latch Plate	6
4	550-557	Plate - Latch	6
5	350-1418	Plunger & Pin Asm.	6
6	550-459	Spring	6
7	548-1857	Solenoid & Diode Asm.	6
8	934-21	Screw	12

**FIGURE
6**

Sliding Panel Assembly (Side View)

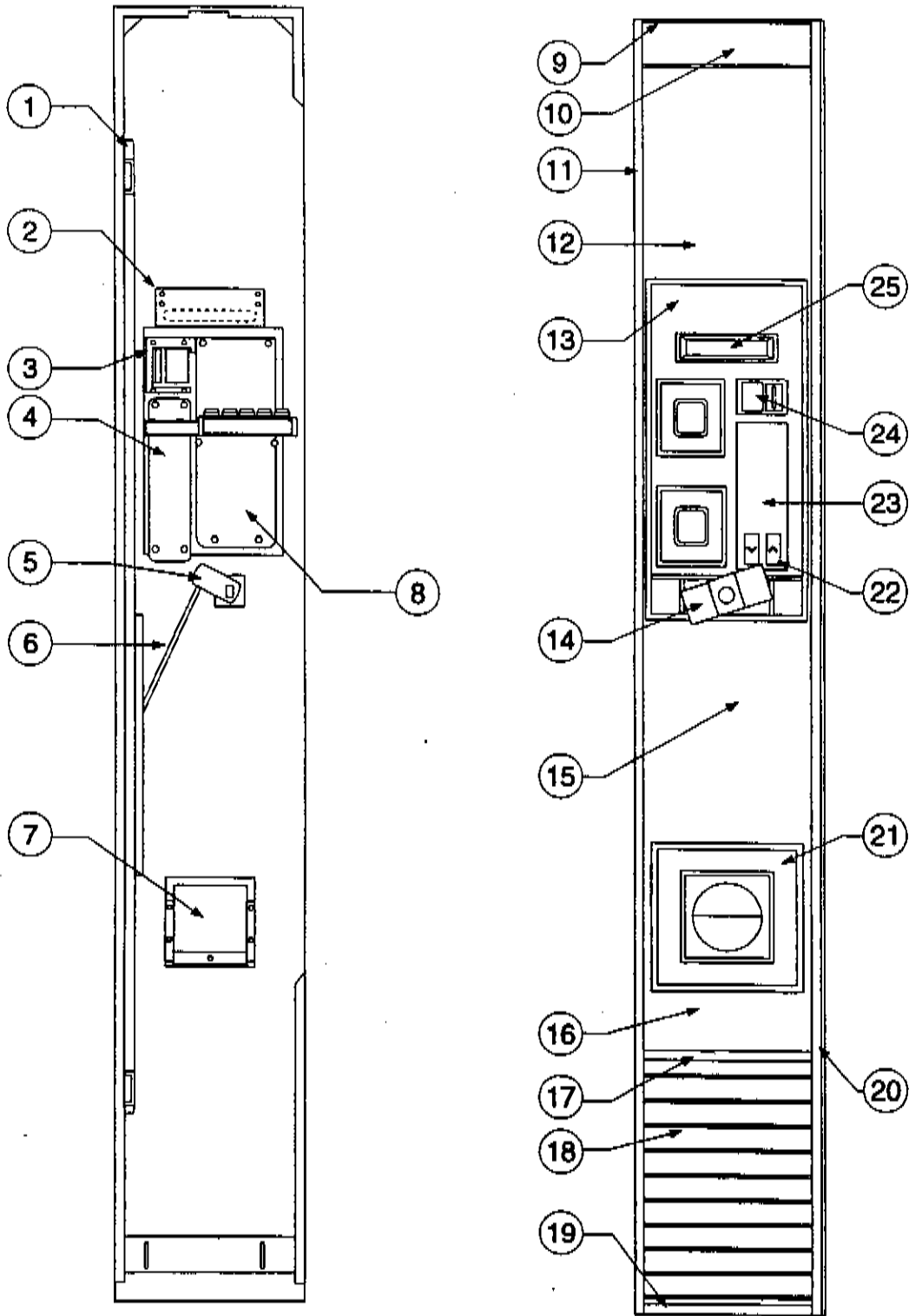

**FIGURE
6**

Figure & Index Number	Rowe Part Number	Description	Quantity Per Assembly
	550-1500	Sliding Panel Assembly	REF
1	550-515	Bracket - Interlock Switch Mounting	1
	934-151	Screw	2
2	526-21286	Switch - Door Interlock	1
3	500-1000-9	Universal Control Board - 550 U.S.A	1
	934-151	Screw	4
4	550-1800	Power Supply Assembly	1
	550-1801	Circuit Board Assembly - Power Supply	1
	550-1802	Cover & Silk Screen Assembly	1
	934-151	Screw	4
5	550-526	Bracket - Transformer Mounting	1
	934-151	Screw	4
6	548-1891	Transformer - Power Supply	1
	924-54	Nut	4
7	548-1845	Filter Assembly	1
	921-262	Screw	2
8	912-75	Fuse - 3 Amp Circuit Breaker	1
	950-176	Washer	2
9	494-906	Angle - Sliding Panel Stop	1
	934-151	Screw	2
10	508-1826	Ballast & Harness Assembly	1
	934-151	Screw	2
11	550-1513	Slug Cup Chute W/A	1
	934-151	Screw	3
12	550-1514	Coin Chute W/A	1
	934-151	Screw	4
13	550-516	Bracket - Slide Bottom	1
	924-59	Nut	2
14	550-1517	Bracket & Channel W/A - Keypad	1
	921-346	Screw	3
15	550-521	Lever Coin Return	1
16	550-508	Spring - Compression	1
17	550-519	Extension - Coin Return Button	1
18	490-5	Roller	1
	490-6	Roller Bushing	1
	934-441	Screw	1
	924-64	Nut	1
19	550-512	Chute - Outer, Coin Mech	1
	550-513	Chute - Inner, Coin Mech	1
20	550-514	Bracket - Coin Mech Chute Mounting	1
	934-151	Screw	4
21	490-353	Spring	1
22	508-804	Service Box	1
	934-151	Screw	4
23	938-8001	Relay - 24V 15 Amp.	1
	934-441	Screw	2

**FIGURE
6A**

Sliding Panel Assembly (Front Panel)



**FIGURE
6A**

Figure & Index Number	Rowe Part Number	Description	Quantity Per Assembly
1	550-1516	Lockbar & Pin Rivet Assembly	1
2	500-1012	Display Board Assembly	1
	938-7000	Pulse Width Modulator	1
	979-268-10	Connector - Header (10 Pin)	1
	979-268-12	Connector - Header (12 Pin)	1
	979-269-50	Connector - Header (Right Angle Pin)	1
	935-2116-102	Resistor Network	1
	921-346	Screw	4
3	550-520	Bracket - Coin Return	1
	921-210	Screw	4
4	550-1806	Selector Keypad Assembly	1
	550-1808	Selector Keypad Base	1
	30837101	Switch - Keyboard 12VDC	2
	70086608	Connector - Header (8 pos.)	1
	70086612	Connector - Header (12 pos.)	1
	80682404	Screw	4
	921-346	Screw	4
5	550-1515	Cam & Pivot Rivet Assembly	1
6	550-518	Rod - Locking Bar	1
	933-7	Retaining Ring	1
7	448-21510	Coin Cup	1
	490-409	Flap - Coin Return Cup	1
	490-424	Pivot Shaft - Coin Return Cup	1
	941-8	Nut	1
	934-419	Screw	5
8	550-529	Bezel Filler Plate	1
	921-210	Screw	8
9	983-35	Trim - Sliding Panel (Clear)	1
	983-34	Trim - Sliding Panel (Black)	1
	934-428	Screw	2
10	985-40-*	Insert - Sliding Panel	1

* Overlay and trim panels are available in several finish colors, indicated by the last dash number of the part number. When ordering this part, it is necessary to indicate the desired color. For example, figure #10 above, P/N 985-40-*, Insert - Sliding Panel, can be ordered in black, P/N 985-40-9, or Roweswood 985-40-1. Refer to the chart below for finish color numbers.

FINISH COLORS

- | | |
|-------------------------|----------------------------|
| - 1 Roweswood | - 12 Port-Au-Prince |
| - 2 Presidential Walnut | - 13 Stainless Steel Mylar |
| - 3 Regency Walnut | - 15 Stainless Steel Mylar |
| - 7 Shadow Silver | - 29 Teak |
| - 9 Black | - 32 Terra Cotta |
| - 10 Golden Leather | - 69 Chamois |
| - 11 Brushed Bronze | - 79 Charcoal Brown |

**FIGURE
6A**

Sliding Panel Assembly (Front Panel - Continued)

Figure & Index Number	Rowe Part Number	Description	Quantity Per Assembly
11	983-1000	Trim - Door, Vertical (Black)	1
	983-1001	Trim - Door, Vertical (Clear)	1
	934-428-	Screw	7
12	985-60-*	Overlay - Sliding Panel	1
13	550-527	Bezel - Standard	1
	934-419	Screw	8
	479-1420	Handle Assemble - Popout	1
14	903-16	Carriage Bolt	2
	924-37	Nut	2
	924-181	Nut	1
	985-61-*	Overlay - Sliding Panel	1
15	985-62-*	Overlay - Sliding Panel	1
17	983-238	Trim - Panel (Black)	1
	983-239	Trim - Panel (Clear)	1
	983-344	Trim Retainer - Sliding Panel	1
	934-307	Screw	3
	694-1405	Overlay - Bottom, Sliding Panel (Black & Silver Genesis)	1
18	985-63-*	Insert - Sliding Panel	1
	694-408	Trim - Sliding Panel, Bottom	1
19	934-307	Screw	3
	983-101	Trim - Door (Clear)	1
	983-102	Trim - Door (Black)	1
20	983-325	Retainer - Trim	1
	934-307	Screw	10
	550-530	Bezel - Coin Return	1
	934-419	Screw	4
21	550-533	Pushbutton	2
22	907-1067	Label - 550 Customer Instruction	1
23	550-507	Button - Coin Return	1
24	550-532	Lens - Message Center	1
25			

**FIGURE
7**

Refrigeration Unit (Illustration not Available)

Figure & Index Number	Rowe Part Number	Description	Quantity Per Assembly
1	111-901	Tray - Evaporator	1
2	111-1217	Accumulator	1
3	448-1829	Thermostat	1
4	448-12211	Valve Assembly - Liquid Suction	1
5	508-224	Tube - Suction, Compressor to Tee	1
6	508-1211	Timer - Solid State	1
7	550-205	Shroud - Condenser Fan	1
8	550-208	Bracket - Drip Tray Mounting	1
9	550-238	Tube - Compressor to Accumulator	1
10	550-239	Tube - Accumulator to Evaporator	1
11	550-241	Gasket - Evaporator Outlet	1
12	550-242	Gasket - Evaporator Intake	1
13	939-2174	Drain Tube	1
14	550-248	Cover - Relay	1
15	550-251	Tubing - Tee to Valve	1
16	550-253	Tubing - Tee to Condenser	1
17	550-254	Tubing - Tee to Discharge Valve	1
18	550-255	Tubing - Condenser to Drier	1
19	550-1201	Base W/A	1
20	550-1202	Condenser	1
21	550-1203	Bracket & Tube W/A	1
22	550-1204	Compressor	1
23	550-1205	Evaporator Housing & Condenser Cover	1
24	550-1208	Blower & Bracket Assembly - Evaporator	1
25	550-1213	Drier Assembly	1
26	550-1214	Fan Assembly - Condenser	1
27	550-1215	Heater Cartridge - Terminated	2
28	550-1217	Evaporator & Drip Pan R/A	1
29	550-1218	Tube Assembly - Capillary	1
30	550-1219	Tube Assembly - Discharge	1
31	550-1246	Switch Assembly - Thermostat	1
32	707-6502	Relay - #KUHP-11D51-24	1
33	938-8001	Relay - 24VDC, 15 Amp.	2

**FIGURE
8**

Universal Control Board

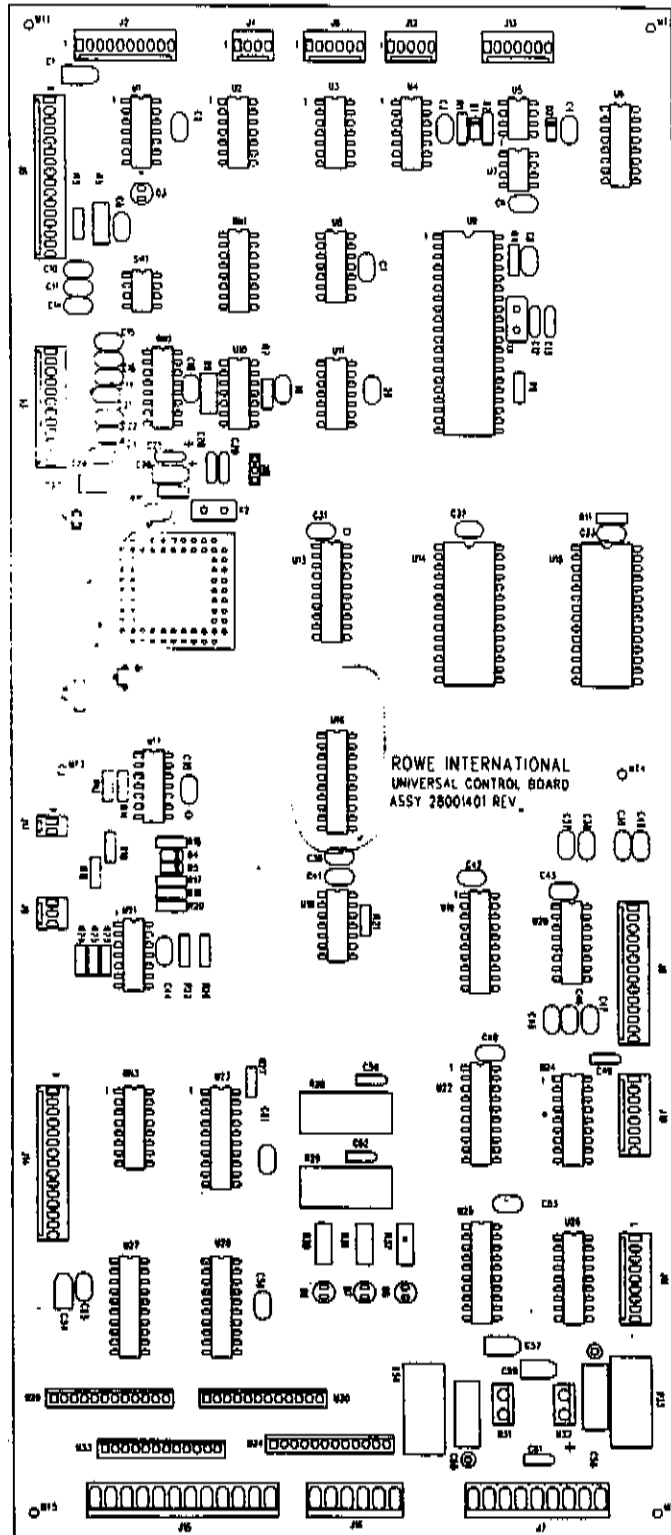

**FIGURE
8**

Universal Control Board

Reference Number	Part Number	Description
C58, C60	70028201	Capacitor - 22 μ F, 50V Rad.
C18, C25, C50, C52	70025301	Capacitor - 1 μ F, 35V 10%
C1, C26, C27, C54, C57, C59	70025302	Capacitor - 15 μ F, 15V 10%
C49, C61	70025303	Capacitor - 47 μ F, 10V 10%
C12, C13, C28, C29	70028705	Capacitor - 22PF, 50V 10%
C2-C8, C10, C11, C14-17		
C19-C24, C30-C33, C35-C48		
C51, C53, C55, C56	70028649	Capacitor - .1 μ F, 50V 10%
X2	25167327	Xtal - Quartz, 10 MHz.
X1	25167318	Xtal - Quartz, 3.6864 MHz. LS - .190"
D1, D2, D4, D5	70035012	Diode 75V .075 Amp.
U21	30800270	IC - Quad 2 input, Norton OP Amp.
U17	30800216	IC - Quad OP Amp.
Q1	30800243	IC - Under Volt Sensor
U18	79940008	IC - Quad 2 input and Gate CMOS
U10, U11	79940014	IC - Hex Schmitt-Trig Inverter CMOS
U6	79940157	IC - Quad 2 input Multiplexer
U19, U22, U25, U27, U28	79940273	IC - Octal D-Flip Flop w/Clear
U13	79940573	IC - Octal D-Latch Tri-State
U5	70033714	IC - 2 Channel Optocoupler
U20	70036901	IC - Darlington Array
U24, U26	70036906	IC - High Current Source Driver
U29, U30, U33, U34	70036908	IC - Quad - High Current, Darlington
U2, U3	30800271	IC - Quad Line Driver
U4, U8	30800272	IC - Quad Receiver
U9	70034704	IC - Dual Uart
U15	70036609	IC - SRAM Bat. 8K x 8 w/RTC
U16	28027101	IC - UCB - Programmed
U23	70037145	IC - Encoder, Priority IDPE-30
U1	70036309	IC - Hex Buffer Open
U32	70036518	IC - Voltage Regulator, 12V Linear
U31	70036521	IC - Voltage Regulator, -12 to -200
R16	799122322	Resistor - 23.2K 1/4 Watt 1%
R13	799123462	Resistor - 34.8K 1/4 Watt 1%
R14	799121003	Resistor - 100K 1/4 Watt 1%
R15, R17-R20, R22-R26	799121004	Resistor - 1M 1/4 Watt 1%
R12	799124990	Resistor - 499 OHM 1/4 Watt 1%
R3, R7, R8, R10, R11, R21	799001123	Resistor - 12K 1/4 Watt 5%
R5, R9, R32	79904391	Resistor - 390 OHM 1/2 Watt 5%

**FIGURE
8**

**Universal Control Board
(Continued)**

Reference Number	Part Number	Description
R30, R31	79904392	Resistor - 3.9K 1/2 Watt 5%
R28, R29, R33, R34	70714201	Resistor - 20 OHM 5 Watt 5%
SW1	70043008	Switch - Dip
D3, D6-D8	70035303	LED - Visible, Red
U7	7994040107	IC - Dual 2 Input Nand GT, CMOS
J2	70076410	Connector - HDR, 10 Position
J3	70076412	Connector - HDR 12 Position
J4	70076404	Connector - HDR 4 Position
J5	70076416	Connector - HDR 16 Position
J7	70080509	Connector - HDR 9 Position
J9	70076403	Connector - HDR 3 Position
J13	70076407	Connector - HDR 7 Position
J6	70076406	Connector - HDR 6 Position
J8	70076414	Connector - HDR 14 Position
J10	70076408	Connector - HDR 8 Position
J11	70076409	Connector - HDR 9 Position
J12	70076405	Connector - HDR 5 Position
J14	70076415	Connector - HDR 15 Position
J15	70080512	Connector - HDR 12 Position
J16	70080506	Connector - HDR 6 Position
J17	70076402	Connector - HDR 2 Position
J18	70078703	Connector - HDR 3 Position
R1, R2	79901181	Resistor - 180 OHM 1/4 Watt 5%
R4, R27	79901102	Resistor - 1K 1/4 Watt 5%
XU15	70073929	Socket - IC
XU-12	25236201	Socket - IC
XU14	70073928	Socket - IC

FIGURE
9

Power Supply Circuit Board

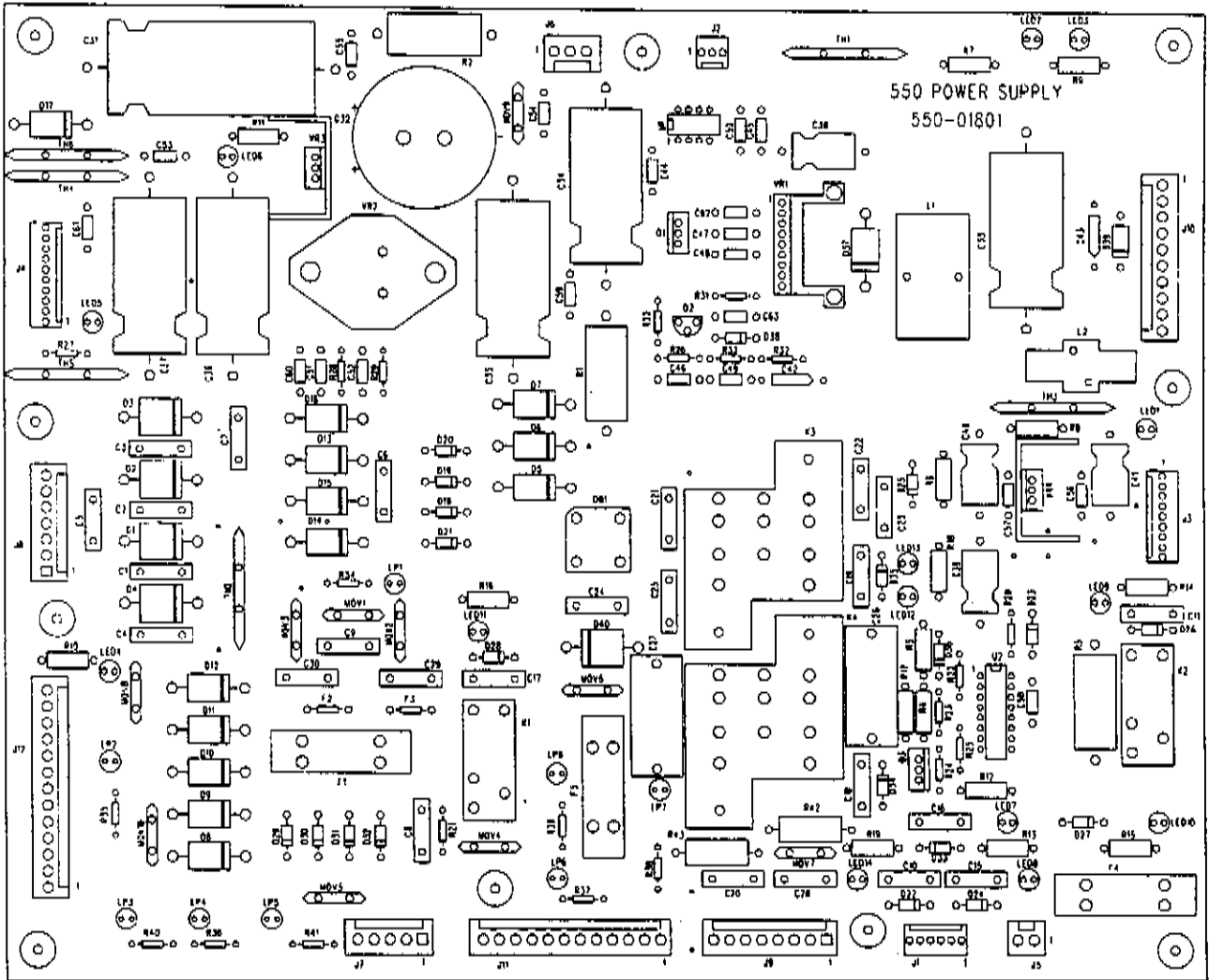

Reference Number	Part Number	Description
C1-C11, C15-C25, C28	203A9H6070-1003	Capacitor - .01 μ F 1KV 20%
C31	203A7F6100-4708	Capacitor - 4700 μ F 50V 20%
C32	70023608	Capacitor - 6800 μ F 63V 20%
C33	203A7C6100-2208	Capacitor - 2200 μ F 16V 20%
C34-C37	203A7F6100-1008	Capacitor - 1000 μ F 50V 20%
C38-C41	70703002	Capacitor - 47 μ F 50V 20%
C42, C43	70025302	Capacitor - 15 μ F 15V 10%
C44-C61	71128649	Capacitor - .1 μ F 50V 10%
C62	203A0H5120-5602	Capacitor - 5600 μ F 100V 10%

FIGURE**9**

Power Supply Circuit Board (Continued)

Reference Number	Part Number	Description
C63	203A0F5110-1201	Capacitor - 120PF 100V 10%
D1-D4	220A028-00006A1	Diode - 50V 6 Amp.
D5-D17	70035004	Diode - 100V 3 Amp.
D18-D35	70035005	Diode - 400V 1 Amp.
D36	70035534	Zener - 11V 1 Watt
D37	220A004-01N5822	Diode - 40V 3 Amp.
D39	221A029-00ICTE5	Diode - 6V 1MA
D40	70706401	Diode - 800V 6 Amp.
DB1	70701803	Diode Bridge - 400V 6 Amp.
F1, F4, F5	262A2R00125D-01	Fuse - 2 Amp. 125V 1/4" x 1-1/4"
F2, F3	262A1R00125A-01	Fuse - Pico, 1 Amp. 125V
FC1-FC6	461A-250600-001	Fuse Holder - 1/4" x 5mm
J1	70076406	Connector - HDR 6 Position
J2	70076403	Connector - HDR 3 Position
J3	70076409	Connector - HDR 9 Position
J4	70076410	Connector - HDR 10 Position
J5	70080502	Connector - HDR 2 Position
J6	70080503	Connector - HDR 3 Position
J7	70080505	Connector - HDR 5 Position
J8	70080507	Connector - HDR 7 Position
J9	70080508	Connector - HDR 8 Position
J10	70080510	Connector - HDR 10 Position
J12	70080512	Connector - HDR 12 Position
J13	70080513	Connector - HDR 13 Position
K1, K2	70042407	Relay - 24V 10Amp.
K3, K4	70706501	Relay - DPDT 24V
XK3, XK4	70706601	Socket - Relay
L1	206A3-2207-0001	Inductor - 220 MHz. 5.5 Amp.
L2	206A1-1005-0001	Inductor - 1MHz. 4 Amp.
LED1-LED3, LED5, LED6, LED8	70035312	LED - Green
LED4	242A-01A02AS-01	LED - Bi-color, Red/Green
LED7, LED9-LED14	70035310	LED - Red
LP1-LP8	240A-0A1201B-01	Lamp - Neon
MOV1-MOV7	70037503	Varistor - 30J 150VRMS
MOV8-MOV10	256A-050008-001	Varistor - 8J 50VRMS
Q1	225A002-02N6121	Transistor - 45V 4 Amp.

Power Supply Circuit Board (Continued)

Reference Number	Part Number	Description
Q2	266A4-0002N2061	Thynsistor - 60V .51 Amp. Continuous
Q3	226A002-0BUZ71A	Transistor - 50V 6 Amp.
R1	200A042044-0181	Resistor - 180 Ohm 5 Watt 5%
R2, R3	200A042044-SX47	Resistor - .47 Ohm 5 Watt 10%
R4, R5	79904102	Resistor - 1K 1/2 Watt 5%
R6, R7	79904391	Resistor - 390 Ohm 1/2 Watt 5%
R8-R19	79904332	Resistor - 3.3K 1/2 Watt 5%
R20, R21	79901105	Resistor - 1M 1/4 Watt 5%
R22	79906103	Resistor - 10K Ohm 1/4 Watt 5%
R23, R24	79906473	Resistor - 47K Ohm 1/4 Watt 5%
R25, R26	79901102	Resistor - 1K 1/4 Watt 5%
R27	79901560	Resistor - 56 Ohm 1/4 Watt 5%
R28	79901101	Resistor - 100 Ohm 1/4 Watt 5%
R29	79901221	Resistor - 220 Ohm 1/4 Watt 5%
R30	79901222	Resistor - 2.2K 1/4 Watt 5%
R31	79901223	Resistor - 22K 1/4 Watt 5%
R32	200A005002-8660	Resistor - 866 Ohm 1/4 Watt 1%
R33	200A005002-6810	Resistor - 681 Ohm 1/4 Watt 1%
R34-R39	79901104	Resistor - 100K 1/4 Watt 5%
R40, R41	79901334	Resistor - 330K 1/4 Watt 5%
TH1-TH6	215A-00RDE-305A	Thermistor - 3 Amp. PTC
U1	230A000003423P	IC - Overvoltage Sensor
U2	70034538	IC - Dual Multivibrator CMOS
VR1	210A-0LAS6330PI	IC - Pulse Width Modulator, 5V
VR2	230A-0000LM338K	IC - Voltage Regulator, 5 Amp.
VR3	230A-0000LM350T	IC - Voltage Regulator, 3 Amp.
VR4	70036518	IC - Voltage Regulator, 12V Linear
C29, C30	70022608	Capacitor - 1000PF 1KV 10%
C26, C27	70712501	Capacitor - .47 μ F 630V
R42, R43	700010916	Resistor - 33 Ohm 1/2W 10%

**FIGURE
10**

Hardware List

Part Number	Description
903-16	Carriage Bolt - 10-24 x 5/8
921-193	Machine Screw - 1/4-20 x 1" Hex Head
921-240	Machine Screw - 10-32 x 1/4"
921-287	Machine Screw - 6-32 x 5" Hex Head Washer
921-310	Machine Screw - 8-32 x 5/16" Hex Head
924-54	Nut - 8-32 Type 6
924-62	Nut - 1/4-20 Type 6
924-64	Nut - 1/4-28 Type 6
924-176	Nut - 3/16 Stud Type 11
933-4	Retaining Ring - Type 10 - G=.250
933-5	Retaining Ring - Type 10 - G=.187
934-29	Screw - Self Tapping, #8 x 3/8" Type Z Hex Head
934-151	Screw - Self Tapping, #8 x 1/4" Type Z Hex Washer Head
934-250	Screw - Self Tapping, #6 x 1/4" Type Z Hex Washer Head - Sems
934-307	Screw - Self Tapping, #8 x 3/8" Type Z Hex Washer Head - Sems
934-317	Screw - Self Tapping, 8-32 x 5/16" Type 23 Hex Washer Head
934-320	Screw - Self Tapping, 6-32 x 5/16" Type 23 Hex Washer Head - Sems
934-419	Screw - Self Tapping, 8-32 x 3/8" Type 23 Hex Washer Head
934-428	Screw - Self Tapping, #8 x 3/8" Type Z Truss
934-443	Screw - Self Tapping, #8 x 1-3/8" Type Z Truss
934-458	Screw - Self Tapping, #8 x 5/8" PLT 30 Truss Hex Washer Head
934-485	Screw - Self Tapping, #8 x 3/8" Type Z Truss Nib
934-508	Screw - Self Tapping, #8 x 5" Type 1 Truss
941-8	Nut - Speed, Type 6 for 1/8" Stud
950-5	Washer - 1/4" Flat
950-15	Washer - #8 Flat
950-226	Washer - Locking
950-344	Washer - #8 Locking
950-383	Washer - .251 Square Hole

Harness List

Part Number	Description
508-1814	Harness - UCB J2 to Display J1
508-1815	Harness - J2 to Customer Keypad J1
508-1816	Harness - Customer Keypad J2 to Service Keypad J1
508-1829	Harness - UCB J12 to Printer
508-1833	Harness - UCB P5 to UBA-2 P3
550-1821	Harness - Interlock
550-1822	Harness - Motor
550-1818	Harness - A/C to Light & Glass
550-1819	Harness - Transformer to Glass
508-1837	Power Cord Assembly - Domestic
550-1862	Refrigeration Power Cord Assembly
550-1825	Harness - Power Supply J7 to UCB J11
550-1827	Harness - Power Supply J15 to UCB J7
550-1828	Harness - UCB to Coin Mech & Power Supply
550-1831	Harness - Power Supply J13 to Filter
550-1833	Harness - UCB J14 to Solenoid Connection
550-1836	Harness - Power Supply J10 to Carriage Motor
550-1837	Harness - Horizontal Display
550-1839	Harness - Power Supply J13 to Filter Load
550-1840	Harness - Harness - Power Supply J16 to Filter
550-1842	Harness - Ballast to Lamp
550-1844	Harness - Ballast Lamp
550-1852	Harness - Carriage Switch
550-1853	Harness - Solenoid Connector
550-1854	Harness - Power Supply J9
550-1855	Harness - Power Supply J1
550-1856	Harness - UCB P15 to Power Supply P16
550-1857	Harness - UCB P3 to Door
550-1859	Harness - Refrigeration Connector
550-1860	Harness - Relay Control
550-1861	Harness - Compressor
550-1863	Solenoid & Diode Wire Assembly
550-1865	Harness - Reset Solenoid Return
550-1866	Harness - Reset Solenoid Coil Set

